

RAPID ALUMINIUM

PRODUCT & SYSTEMS CATALOGUE

rapid
ALUMINIUM

2023



RAPID ALUMINIUM

The experts in aluminium profiles & extrusions
Industry preferred aluminium supplier for both quality and service.

MELBOURNE (Head Office)
27 Nathan Road
Dandenong VIC 3175
PH: (03) 9792 0344
FAX: (03) 9792 4954
Email: sales@rapidal.com.au

www.rapidal.com.au



POWDERCOATING – MINIMUM INVOICE

ALL Powdercoat orders with a total order value under \$1,000+gst will incur a min surcharge fee. This fee will be at the discretion of Rapid Aluminium based on the availability and price of the powder required to complete the order. For further pricing information contact the sales team.

[20 year powder coating warranty now available](#)



ANODISED & MILL FINISH MATERIAL

ALL Anodised and Mill Finish orders placed with Rapid Aluminium for PICKUP must be ordered with at least 24hrs of notice prior to pick up required.

CUTTING SERVICE

A fee of \$6.50+gst per cut applies. Please advise us via email if this service is required prior to pick up of goods/order. (Phone instructions will not be accepted) The cutting service is ONLY for “docking” the material and is NOT millimetre perfect. This service will not be provided after the order transaction is complete.

CONDITIONS OF SALE

All goods sold by Rapid Aluminium to the purchaser shall remain the absolute property of Rapid Aluminium and no right, title or transfer of interest of any kind shall transfer to the purchaser until payment in full is made to Rapid Aluminium in respect of the goods. (PRICES ARE SUBJECT TO CHANCE WITHOUT PRIOR NOTICE)

If it becomes necessary to institute legal proceedings to recover unpaid debts to Rapid Aluminium, all discounts showing on unpaid invoices become null and void and the total list price becomes payable. Full Terms and Conditions of Sale appear on the reverse of all invoices (see over).

RETURNS / CREDIT CLAIMS

- Goods being returned will not be accepted without prior approval from management at Rapid Aluminium.
- Invoice number, PO number and date are required on all claims.
- Freight costs on returned goods must be paid by the sender.
- All claims for loss, damage, shortages or price differences must be made within 7 days after invoice.
- Custom made or specially ordered goods are NON-RETURNABLE and NON-REFUNDABLE.

DELIVERY SERVICE

A delivery service is available – please enquire on the cost when placing your order.



MANUFACTURING & ESTIMATING SOFTWARE SUPPORT

We are proud to announce that the RAPID ALUMINIUM PROFILES are now supported by LOGIKAL by ORGADATA. We are excited to show you what it can do and how it can help improve your business in more ways than you think. LOGIKAL is the best software for windows, doors & curtain wall systems in the market today.

It is the software solution you have been waiting for... Estimating projects made easy, with a user-friendly layout and an intuitive user interface that will surely be welcomed by learners regardless of age and background. It's going to be easy and quick to Quote, Order, Produce and create Shop drawings with LOGIKAL.

LogiKal[®]
Software you can build on

KEY BENEFITS & FEATURES

- **Estimating** – Quote with ease and present pricing to your client with your very own personalised Quote report.
- **Fabrication reports** – Produce professional detailed and accurate information for assembling and cutting with a simple click of a button. All reports are customizable to your own needs & requirements.
- **CNC connection (coming soon)** – Pre-program and customize CNC data communicated directly to your CNC machinery, improving efficiency, saving you time & money not to mention avoiding costly errors.
- **Structural Analysis** – You get to define profiles to be used in different scenarios and see how design changes affect your Elevation in real-time.
- **Shop Drawing** – Gives you the ability to produce detailed cross-sectional Shop drawings automatically generated from your selected items.
- **Measure on site with App** – Bring your project to your phone or tablet, change sizes and send the information back to LogiKal. Project changes are automatically updated in real-time.



For more information send an email to info@orgadata.com.au or contact your support team at RAPID ALUMINIUM



76mm & 101.6mm SLIDING WINDOW							PAGE	
2							2	
3								3
4								4
5								5
101.6mm & 150mm APARTMENT DOOR								
10							10	
11							11	
12							12	
13							13	
14							14	
15							15	

Please note: Images are not to scale

101.6mm & 150mm APARTMENT DOOR								
PAGE						PAGE		
16	 RAD115 FLAT FILLER (HEAD)	 RAD116 THRESHOLD (SILL)	 RA131 OXO ADAPTOR	 CF406 POCKET FILLER	 CF705 DG HIGHLIGHT ADAPTOR	 CF452 SG HIGHLIGHT ADAPTOR	16	
17	 CF430 113mm SUBSILL	 CF420 120mm SUBSILL	 CF431R 131mm SUBSILL	 CF462 144mm SUBSILL	 CF462N 148mm SUBSILL	 CF630 TO SUIT TRIPLE TRACK 163mm SUBSILL	17	
18	 CF437 STANDARD SUBHEAD	 CF458 2 PIECE SUBHEAD	 CF457 2 PIECE SUBHEAD BEAD	 CF477 H/D 40mm SUBHEAD	 CF637 150mm SUBHEAD (50mm)	 CF658 2 PIECE SUBHEAD	18	
101.6mm & 165mm SEMI-COMMERCIAL DOOR								
24	 RSD501 101.6mm HEAD TRACK	 RSD502 101.6mm SILL TRACK	 RSD503 165mm HEAD TRACK	 RSD504 165mm SILL TRACK	 RSD524 165mm 2 PART SUBHEAD	 RSD525 165mm SUBSILL	24	
25	 BW400 FRAME	 RSW404 RECEIVER CHANNEL 101.6mm	 RSD505 165mm JAMB	 RSD506 JAMB RECEIVER	 RSD507 165mm DOUBLE FLYSCREEN RECEIVER	 RSD508 165mm SINGLE FLYSCREEN RECEIVER	 RSD515 SNAP IN REC CHANNEL	25
26	 RSW408 SG LOCK STILE	 RSW410 SG INTERLOCK	 RSW412 SG BOXED INTERLOCK	 RSW406 SG RAIL	 RSW418 SG MALE MEETING STILE	 RSW414 SG FEMALE MEETING STILE	26	
27	 RSW416 SG BOXED FEMALE MEETING STILE	 RSD513 HD BOXED SG FEMALE MEETING STILE	 RSD509 SG FLY DOOR INTERLOCK	 RSD511 SG FLY DOOR INTERLOCK HD	 RSD528 SECURITY DOOR INTERLOCK		27	
28	 RSW409 DG LOCK STILE	 RSW411 DG INTERLOCK	 RSW413 DG BOXED INTERLOCK	 RSW407 DG RAIL	 RSW419 DG MALE MEETING STILE	 RSW415 DG FEMALE MEETING STILE	28	
29	 RSW417 DG BOXED FEMALE MEETING STILE	 RSD514 HD BOXED DG FEMALE MEETING STILE	 RSD510 DG FLY DOOR INTERLOCK	 RSD512 DG FLY DOOR INTERLOCK HD			29	
30	 RSD520 THRESHOLD	 RSD521 THRESHOLD	 RSD523 FSF FLYSCREEN ADAPTOR	 RSD526 SLOTTED SILL SUPPORT	 RSD527 SECURITY DOOR FRAME	 RSW421 FLAT FILLER	30	

Please note: Images are not to scale

CENTRE GLAZE (101.6mm x 44.4mm)

PAGE	CENTRE GLAZE (101.6mm x 44.4mm)						PAGE
36	 BW400 FRAME	 BW402 SILL	 CF403 SILL BEAD	 CF403B SILL BEAD SLOPED	 CF405 FLAT FILLER		36
37	 BW401 HD FRAME	 CF472 HD SILL/TRANSOM	 BW444 HD ADAPTOR	 BW404 STD ADAPTOR	 BW436 NARROW FRAME	 CF450 101.6 x 33 FRAME	37
38	 BW427 MATING MULLION	 CF428 HD MATING MULLION	 CF423 TRANSOM COC CLOSER	 CF425 TRANSOM COC FILLER	 CF470 BACK TO BACK ADAPT	 CF406 POCKET FILLER	38
39	 CF407 45mm DOOR STOP	 CF432 35mm DOOR STOP	 CF433 40mm DOOR STOP	 CF416 35mm SASH STOP	 CF7124 35mm ACOUSTIC STOP	 CF4516 50mm SASH STOP	39
40	 CF467 50mm Sash	 CF466 35mm Sash	 CF451 FIXING REVEAL ADAPTOR	 CF471 FIXING ADAPTOR	 CF484 30mm FIXING REVEAL ADAPTOR	 CF485 40mm FIXING REVEAL ADAPTOR	40
41	 CF486 50mm FIXING REVEAL ADAPTOR	 CF473 FIXING ADAPTOR	 CF488 PLASTER ADAPTOR				41
42	 CF8131 44.4mm PLAIN FRAME	 BW418 101.6mm CORNER POST					42
43	 CF701 FRAME	 CF702 SILL	 CF703 SILL BEAD	 CF704 ADAPTOR	 CF706 POCKET FILLER	 CF707 45mm DOOR STOP	43
44	 CF701L 50mm FRAME	 CF702L 50mm SILL	 CF703L 50mm BEAD	 CF704L ADAPTOR	 CF716 35mm SASH STOP	 CF717 50mm SASH STOP	44
45	 CF727 MATING MULLION	 CF728 MATING MULLION	 CF772 MATING MULLION	 CF718 101.6mm CORNER POST			45
46	 CF751 50mm POCKET FRAME	 CF752 50mm POCKET SILL	 CF753 50mm POCKET SILL BEAD	 CF754 50mm POCKET ADAPTOR	 CF7528 50mm POCKET SELF MATING MULLION	 CF405 FLAT FILLER	46

Please note: Images are not to scale

CENTRE GLAZE (101.6mm x 44.4mm)								
PAGE						PAGE		
47	 CF756 POCKET FILLER	 CF757 45mm DOOR STOP	 CF758 50mm SASH STOP			47		
48	 CF437 STANDARD SUBHEAD	 CF458 2 PIECE SUBHEAD	 CF457 2 PIECE SUBHEAD BEAD	 CF477 H/D 40mm SUBHEAD		48		
49	 CF430 113mm SUBSILL	 CF420 120mm SUBSILL	 CF420HD 120mm SUBSILL	 CF431R 131mm SUBSILL	 CF462 144mm SUBSILL	49		
50	 CF462N 148mm SUBSILL	 CF463N 154mm SUBSILL				50		
51	 CF438 STANDARD THRESHOLD	 CF439 OPEN OUT THRESHOLD	 CF489 OPEN IN THRESHOLD	 CF468 DISABLED THRESHOLD	 CF469 INCLINE WHEELCHAIR THRESHOLD	 CF478 WHEELCHAIR THRESHOLD	51	
600 SERIES SINGLE GLAZE (150mm x 44.4mm)								
54	 BW601 150mm SG FRAME	 BW602 150mm SG SILL	 CF603 150mm SILL BEAD	 BW404 STD ADAPTOR	 BW444 HD ADAPTOR	 CF405 FLAT FILLER	54	
55	 CF685 150mm PLAIN FRAME	 BW627 SELF MATING MULLION	 CF429 PLANT ON DOOR STOP	 CF429C PLANT ON DOOR STOP	 CF607 45mm DOOR STOP	 CF616 35mm SASH STOP	 CF406 POCKET FILLER	55
600 SERIES DG (150mm x 50mm)								
56	 DG601 150mm DG MAIN FRAME	 DG602 150mm DG SILL	 DG603 150mm DG SILL BEAD	 DG627 150mm DG SELF MATING MULLION	 CF704 ADAPTOR	 CF706 POCKET FILLER	56	
57	 CF637 150mm SUBHEAD (50mm)	 CF658 2 PIECE SUBHEAD	 CF457 2 PIECE SUBHEAD BEAD	 CF630 163mm SUBSILL	 CF669 INCLINE WHEELCHAIR THRESHOLD		57	
300 SERIES CAPTIVE (76mm x 35mm)								
59	 CF301 76mm Main Frame	 CF302 76mm Sill	 CF303 76mm Sill Bead	 CF304 76mm Glazing Adaptor	 CF305 76mm Flat Filler	 CF306 76mm Pocket Filler	59	

Please note: Images are not to scale

300 SERIES CAPTIVE CONT (76mm x 35mm)

PAGE							PAGE
60	 CF332 35mm Door Stop	 CF307 45mm Door Stop	 CF316 35mm Sash Stop	 CF318 76mm Corner Post			60
61	 CF351 FIXING/REVEAL ADAPTOR	 CF330 SUBSILL	 CF337 SUBHEAD				61

300 SERIES DG (76mm x 35mm)

62	 DG311 76mm DG FRAME	 DG312 76mm DG SILL	 DG313 76mm DG SILL BEAD	 DG314 76mm DG ADAPTOR	 DG315 76mm POCKET FILLER	 CF305 76mm Flat Filler	62
63	 DG316 38mm DOOR STOP	 DG317 45mm DOOR STOP	 DG318 35mm SASH STOP				63

100mm FRONT GLAZE SG (100mm X 50mm)

66	 CF101CW STANDARD MAIN FRAME	 CF102CW SILL/TRANSOM	 CF104 SILL/TRANSOM BEAD	 CF115CW BOXED SILL/TRANSOM	 CF105 FLAT FILLER (CF102CW)	 CF106 POCKET FILLER	66
67	 CF108CW SILL/TRANSOM	 CF109CW SILL/TRANSOM BEAD	 CF110CW COVER TRANSOM	 DG117 COVER BEAD	 CF114CW MULLION	 CF113 STRUCTURAL SELF MATING MULLION	67
68	 CF156 50mm SASH STOP	 CF116 35mm SASH STOP	 CF125 FEMALE SPLIT MULLION	 CF126 MALE SPLIT MULLION	 CF128CW STD FEMALE SPLIT MULLION	 CF127CW STD MALE SPLIT MULLION	68
69	 CF107 45mm DOOR STOP	 CF117 100mm SPLICE BAR	 CF405 FLAT FILLER	 CF112 STRUCTURAL MULLION			69

100mm FRONT GLAZE DG (100mm X 50mm)

70	 DG101 STANDARD MAIN FRAME	 DG106 POCKET FILLER	 DG108 INTERNAL TRANSOM	 DG109 INT TRANSOM BEAD	 DG112 DG BOXED SILL/TRANS	 DG113 DG FG EXT BEAD	 DG114 HEAD/JAMB TRANSOM	70
----	---	-----------------------------------	--------------------------------------	--------------------------------------	---	------------------------------------	---------------------------------------	----

Please note: Images are not to scale

PAGE		100mm FRONT GLAZE DG (100mm X 50mm)										PAGE	
71												71	
72												72	
73												73	
74												74	
75												75	
76												76	
		150mm FRONT GLAZE SG (150mm X 50mm)											
77												77	
78												78	
79												79	











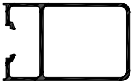
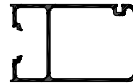
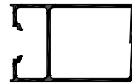
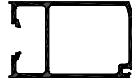
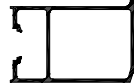
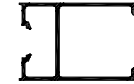





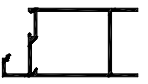
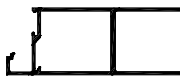
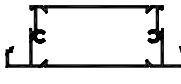



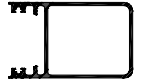
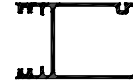

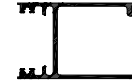
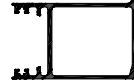
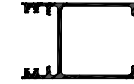
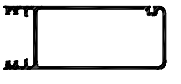
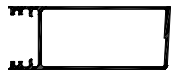

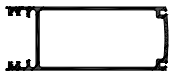

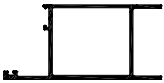
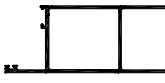
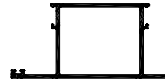



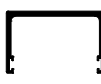



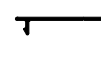

Please note: Images are not to scale

PAGE		150mm FRONT GLAZE DG (150mm X 50mm)						PAGE	
80								80	
81								81	
82								82	
83								83	
		100mm FLUSH GLAZE (100mm X 50mm)							
86								86	
87								87	
88								88	
89								89	











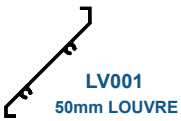
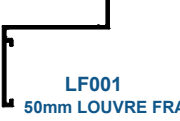

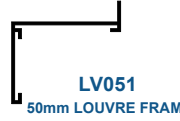



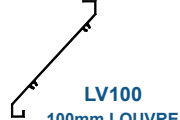



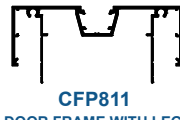













Please note: Images are not to scale

PAGE	150mm FLUSH GLAZE (100mm X 50mm)					PAGE	
90	 RA261 150mm SG FRAME	 RA265 FLAT FILLER	 RA262 SG BOX TRANSOM	 RA266 FEMALE MULLION	 RA267 MALE MULLION	90	
91	 RA271 150mm DG FRAME	 RA272 DG BOX TRANSOM	 RA276 DG FEMALE MULLION	 RA268 BLIND FEMALE MULLION	 CF652 SELF MATING MULLION	91	
92	 RA278 DG SUBSILL	 RA279 SG SUBSILL	 RA280 SG SUBHEAD	 RA281 DG SUBHEAD	 CF685 150mm Plain Frame	92	
FLUSH GLAZE CAPS & PLANT ON ADDITIONS							
93	 CF243 16mm SNAP COVER	 CF244 16mm COVER RETURN	 CF256 20mm SNAP COVER	 CF257 20mm RETURN COVER	 CF254 16mm DG RETURN COVER	 CF253 DG ADAPTOR	93
94	 CF250 SG PLANT ON BASE	 CF260 DG PLANT ON BASE					94
INSERTIONS - AWNING SASHES							
98	 CF415 35mm GROOVED SASH	 CF415B 35mm FLAT FACE SASH	 CF417 SG SASH BEAD	 CF016 DG SASH BEAD	 CF475 35mm GROOVED SASH	 CF475B 35mm FLAT FACE SASH	98
99	 CF460H SASH HINGE	 CF435 35mm SLOPED SASH	 CF414 SASH BEAD	 CFH3 35mm SASH STAKE			99
100	 CF4515 50mm SASH	 CF4517 50mm SASH BEAD	 CF417 SASH BEAD	 CF016 DG SASH BEAD	 CFH50 50mm SASH STAKE		100

Please note: Images are not to scale

<p style="text-align: center;">INSERTIONS - 900 DOOR SERIES SINGLE GLAZE 44mm</p>								
PAGE						PAGE		
103	 CF907 SG PLAIN STILE	 CF908 SG SLIDING STILE	 CF909 SG HINGE STILE	 CF910 SG LOCK STILE	 CF911 SG MEETING STILE	 CF912 SG PIVOT STILE	103	
104	 CF001 SG SLIDING STILE	 CF002 SG HINGE STILE	 CF003 SG LOCK STILE	 CF004 SG PIVOT STILE	 CF005 SG PLAIN STILE	 CF006 SG MEETING STILE	104	
105	 CF411 SG TOP RAIL	 CF412 SG BOTTOM RAIL	 CF413 SG 123mm MID RAIL	 CF414 SG BEAD	 CF426 SG 45mm RAIL	 CF448 BOTTOM RAIL BUG STRIP	105	
<p style="text-align: center;">INSERTIONS - 900 DOOR SERIES DOUBLE GLAZED 44mm</p>								
106	 CF917 DG PLAIN STILE	 CF918 DG SLIDING STILE	 CF919 DG HINGE STILE	 CF920 DG LOCK STILE	 CF921 DG MEETING STILE	 CF922 DG PIVOT STILE	106	
107	 CF021 DG SLIDING STILE	 CF022 DG HINGE STILE	 CF023 DG LOCK STILE	 CF024 DG PIVOT STILE	 CF025 DG PLAIN STILE	 CF026 DG MEETING STILE	107	
108	 CF931 DG TOP RAIL	 CF932 DG BOTTOM RAIL	 CF933 DG 100mm MID RAIL	 DG 150mm MID RAIL	 SF061 DG DOOR BEAD	 CF448 BOTTOM RAIL BUG STRIP	108	
<p style="text-align: center;">DOOR & GLAZING CHANNELS MISCELLANEOUS</p>								
110	 CF421 TRACK INSERT	 CF422 FLOOR GUIDE	 CF424 DOOR GUIDE	 CF429 PLANT ON DOOR STOP	 CF441 INTERLOCK ADAPTOR	 CF446 GUIDE/RECIEVER	 CF447 RECEIVER COVER	110
111	 CF445 PLANT SINGLE TRACK	 CF449 PLANT ON DOOR STOP	 CF455 MEETING STILE ADAPTOR	 CF461 TOP TRACK	 CF453 114mm OVERHEAD TRACK	 CF454 OVERHEAD TRACK PELMET	 END CAP CFH453EC	111
113	 CF015 24mm 2 PIECE BASE	 CF016 2 PIECE BEAD	 CF017 24mm GLAZING CHANNEL	 CF018 50mm 2 PIECE BASE	 CF417 2 PIECE BEAD			113

Please note: Images are not to scale

		LOUVRES						
PAGE								PAGE
114	 LV001 50mm LOUVRE	 LF001 50mm LOUVRE FRAME	 LV050 50mm LOUVRE	 LV051 50mm LOUVRE FRAME	 LV7061 CLIP ON LOUVRE	 LV7049 LOUVRE CLIP	114	
115	 LV9517 SUBSTATION LOUVRE	 LF436 NARROW PLAIN FRAME	 LV100 100mm LOUVRE	 LV101 100mm LOUVRE FRAME			115	
PARTITIONING - 800 SERIES: 100mm (TO SUIT 64mm STUD)								
123	 CFP810 CEILING CHANNEL	 CFP812 FLAT CEILING CHANNEL	 CFP811 DOOR FRAME WITH LEGS	 CFP803 WINDOW SILL	 CFP801 WINDOW FRAME	 CFP805 GLAZING ADAPTOR	123	
124	 CFP804 SILL BEAD	 CFP806R POCKET FILLER	 CFP807 45mm DOOR STOP	 CFP809 35mm DOOR STOP			124	
PARTITIONING - 900 SERIES: 131mm (TO SUIT 90mm STUD)								
125	 CFP900 WINDOW FRAME	 CFP901 DOOR FRAME	 CFP902 CEILING CHANNEL	 CFP903 WINDOW SILL	 CFP904 SILL BEAD	 CFP905 GLAZING ADAPTOR	125	
126	 CFP907 45mm DOOR STOP	 CFP909 38mm DOOR STOP	 CF306 POCKET FILLER				126	
PARTITIONING - 600 SERIES: 190mm (TO SUIT 64mm STUD)								
128	 CFP601 WINDOW FRAME	 CFP602 CEILING CHANNEL	 CFP610 CEILING CHANNEL	 CFP611 DOOR FRAME	 CFP607 45mm DOOR STOP	 CFP609 35mm DOOR STOPS	 CFP506 POCKET FILLER	128

Please note: Images are not to scale

76mm & 101.6mm SLIDING WINDOW

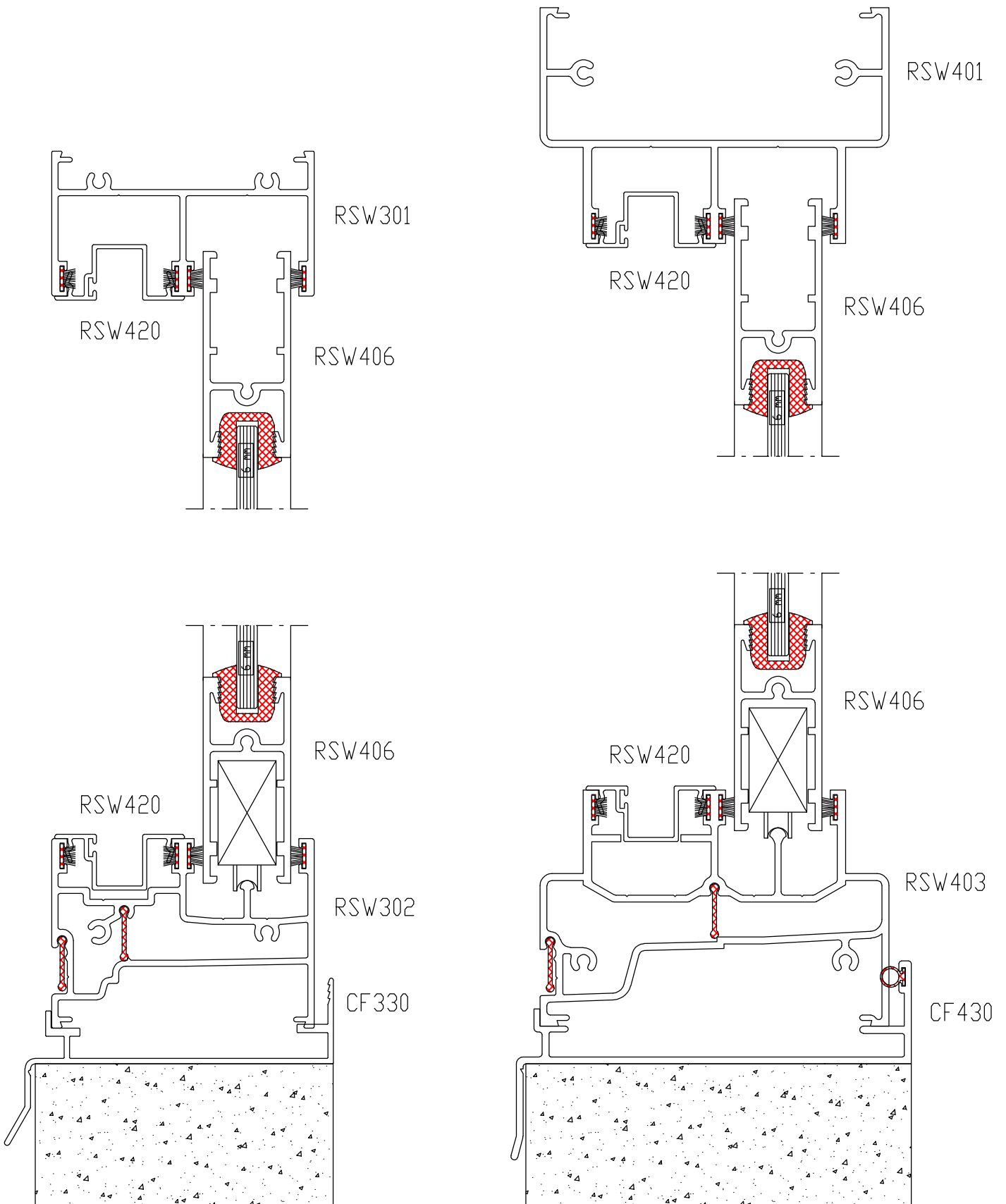

*****Please note: Images are not to scale*****

76mm & 101.6mm SLIDING WINDOW

HEADS, SILL TRACKS & RECEIVER

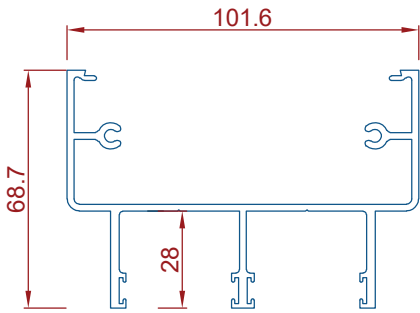

RSW401 - 101.6mm Window Head

(Accepts: BW404, BW444, CF405, CF470, CF704, CF704L, ALL 4" Fixing Adaptors & Accepts: **CFH81**)

Length	Offered Finishes
5.1mtr	Mill / Natural Anodised / Powdercoated

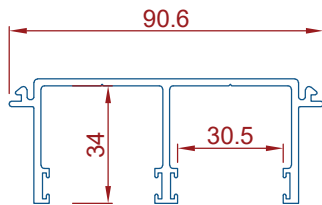

RSW402 - 101.6mm Snap in Head

(Accepts: ALL 4" Frame Sills)
(Accepts: **CFH81**)

Length	Offered Finishes
5.1mtr	Mill / Natural Anodised / Powdercoated

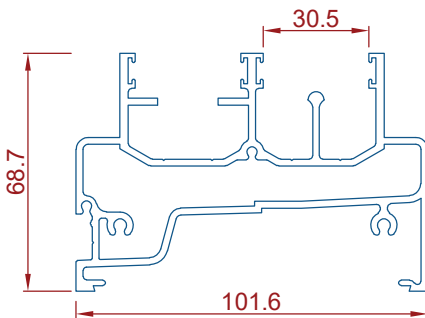

RSW403 - 101.6mm Closed Sill Slotted

(Accepts: BW404, BW444, CF405, CF470, CF704, CF704L, ALL 4" Fixing Adaptors & Accepts: **CFH81**)

Length	Offered Finishes
5.1mtr	Mill / Natural Anodised / Powdercoated

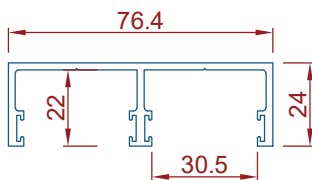

RSW404 - 101.6mm Double Receiver Channel

(Accepts: **CFH80**)

Length	Offered Finishes
5.4mtr	Mill / Natural Anodised / Powdercoated

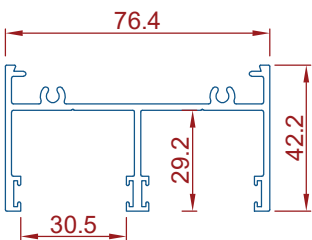

RSW301 - 76mm Window Head

(Accepts: CF304, CF305, CF351, DG314)
(Accepts: **CFH81**)

Length	Offered Finishes
5.1mtr	Mill / Natural Anodised / Powdercoated

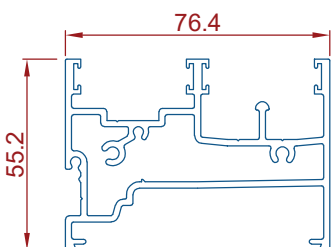

RSW302 - 76mm Window Sill Slotted

(Accepts: CF304, CF305, CF351, DG314) (Accepts: **CFH81**)

Length	Offered Finishes
5.1mtr	Mill / Natural Anodised / Powdercoated

Please note: Images are not to scale

76mm & 101.6mm SLIDING WINDOW

JAMBS, INFILLS & FLYSCREEN ADDITIONS

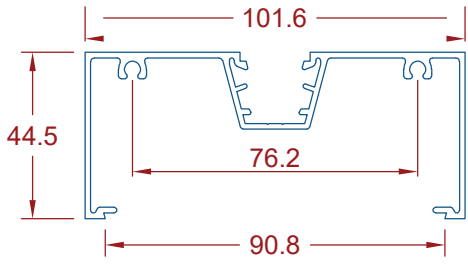

BW400 - Standard Frame (101.6mm Jamb Option)

(Jamb to be used with RSW404 & CF406)

Length	Offered Finishes
6.5mtr	Mill / Natural Anodised / Powdercoated

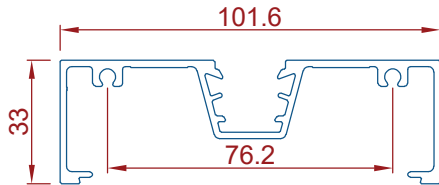

CF450 - 33mm Std Main Frame (101.6 x 33)

(Accepts: CF405, CF406, CF470, RAD131)

Length	Offered Finishes
6.5mtr	Mill / Natural Anodised / Powdercoated

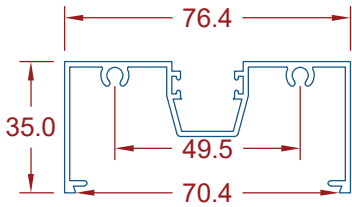

CF301 - 76mm Frame (76mm Jamb Option)

(Jamb to be used with RSW404 & CF306)

Length	Offered Finishes
6.5mtr	Mill / Natural Anodised / Powdercoated

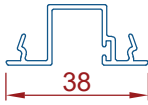

RSW420 - Fly Screen Adaptor

(Accepts: RSW301, RSW302 RSW401, RSW402, RSW403, RSW404)

Length	Offered Finishes
5.4mtr	Mill / Natural Anodised / Powdercoated



RSW421 - Flat Filler

(Accepts: RSW301, RSW302 RSW401, RSW402, RSW403, RSW404)

Length	Offered Finishes
5.4mtr	Mill / Natural Anodised / Powdercoated

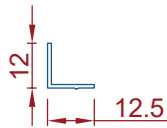

RSW422 - Fly Screen Adaptor

(Face fix to RSW421)

Length	Offered Finishes
5.4mtr	Mill / Natural Anodised / Powdercoated

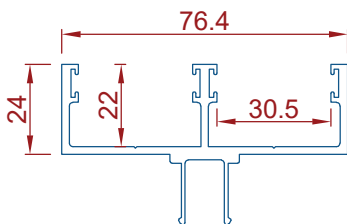

RSW423 - Clip In Receiver

(Clips into BW400 series pockets & CFH80)

Length	Offered Finishes
5.4mtr	Mill / Natural Anodised / Powdercoated

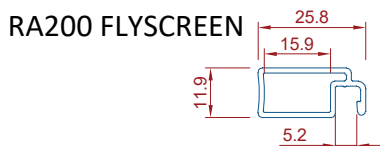

RA200 FLYSCREEN

CFH30 CORNER STAKE



RSD528 INTERLOCK

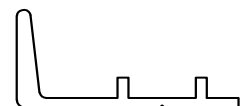

Please note: Images are not to scale

76mm & 101.6mm SLIDING WINDOW

SINGLE GLAZE STILES & RAILS TO SUIT 6mm - 12.76mm GLASS

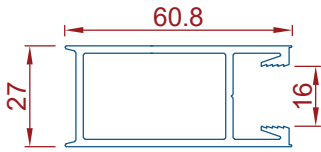

RSW408 - SG Lock Stile (16mm Pocket)

(Accepts: 6mm to 12.76mm Glass)

Length	Offered Finishes
5.4mtr	Mill / Natural Anodised / Powdercoated

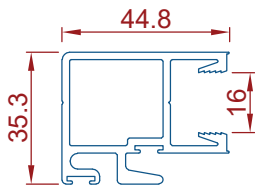

RSW410 - SG Standard Interlock (16mm Pocket)

(Accepts: CFH80, 6mm to 12.76mm Glass)

Length	Offered Finishes
5.4mtr	Mill / Natural Anodised / Powdercoated

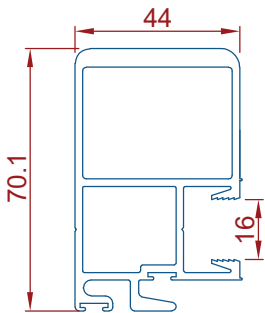

RSW412 - SG Boxed Interlock (16mm Pocket)

(Accepts: CFH80, 6mm to 12.76mm Glass)

Length	Offered Finishes
5.4mtr	Mill / Natural Anodised / Powdercoated

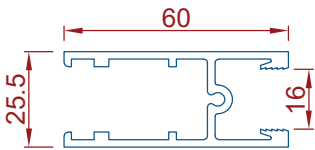

RSW406 - SG Rail (16mm Pocket)

(Accepts: 6mm to 12.76mm Glass)

Length	Offered Finishes
5.1mtr	Mill / Natural Anodised / Powdercoated

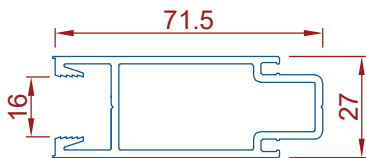

RSW418 - SG Male Meeting Stile (16mm Pocket)

(Accepts: CFH96, 6mm to 12.76mm Glass)

Length	Offered Finishes
5.4mtr	Mill / Natural Anodised / Powdercoated

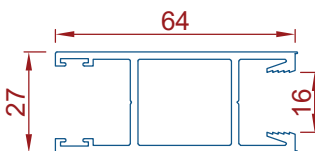

RSW414 - SG Female Meeting Stile (16mm Pocket)

(Accepts: CFH80, 6mm to 12.76mm Glass)

Length	Offered Finishes
5.4mtr	Mill / Natural Anodised / Powdercoated

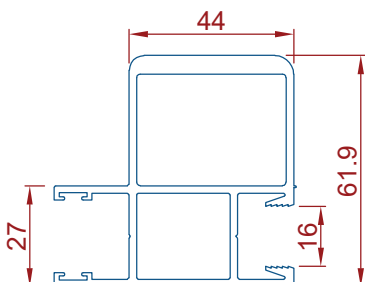

RSW416 - SG Med Boxed Female Meeting Stile

(Accepts: CFH80, 6mm to 12.76mm Glass)

Length	Offered Finishes
5.4mtr	Mill / Natural Anodised / Powdercoated

Please note: Images are not to scale

76mm & 101.6mm SLIDING WINDOW

DOUBLE GLAZE STILES & RAILS TO SUIT 20mm IGU'S

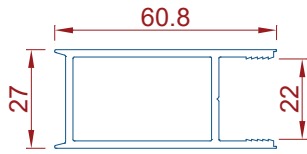

RSW409 - DG Lock Stile

(Accepts: 20mm IGU)

Length	Offered Finishes
5.4mtr	Mill / Natural Anodised / Powdercoated

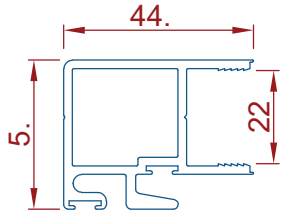

RSW411 - DG Standard Interlock

(Accepts: CFH80 & 20mm IGU)

Length	Offered Finishes
5.4mtr	Mill / Natural Anodised / Powdercoated

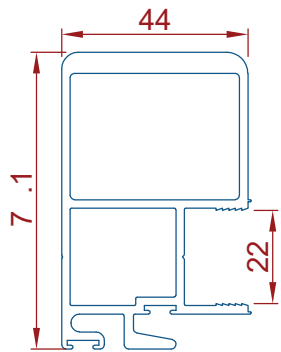

RSW413 - DG Boxed Interlock

(Accepts: CFH80 & 20mm IGU)

Length	Offered Finishes
5.4mtr	Mill / Natural Anodised / Powdercoated

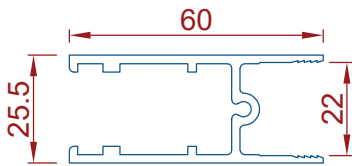

RSW407 - DG Rail

(Accepts: 20mm IGU)

Length	Offered Finishes
5.1mtr	Mill / Natural Anodised / Powdercoated

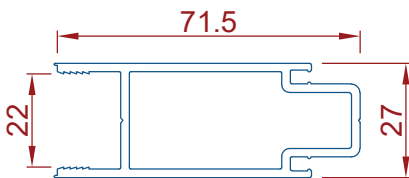

RSW419 - DG Male Meeting Stile

(Accepts: CFH96, 20mm IGU)

Length	Offered Finishes
5.4mtr	Mill / Natural Anodised / Powdercoated

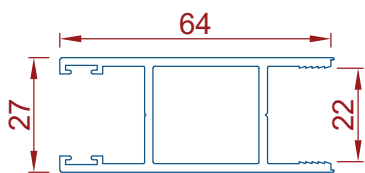

RSW415 - DG Female Meeting Stile

(Accepts: CFH80, 20mm IGU)

Length	Offered Finishes
5.4mtr	Mill / Natural Anodised / Powdercoated

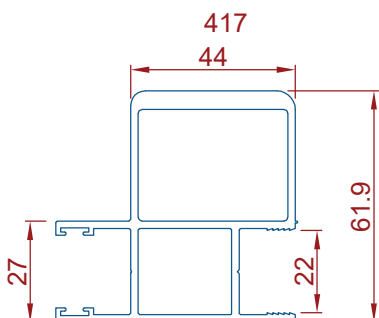

RSW417 - DG Med Boxed Female Meeting Stile

(Accepts: CFH80, 20mm IGU)

Length	Offered Finishes
5.4mtr	Mill / Natural Anodised / Powdercoated

Please note: Images are not to scale

76mm & 101.6mm SLIDING WINDOW

HARDWARE ITEMS (RUBBERS)

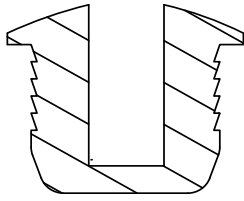

CFH90 - 6mm-6.76mm Glazing Channel

Length	Colour
80mtr	Black

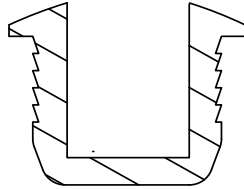

CFH92 - 10mm-10.76mm Glazing Channel

Length	Colour
100mtr	Black

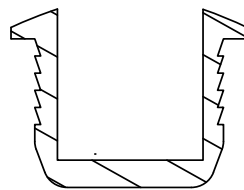

CFH93 - 12mm-12.76mm Glazing Channel

Length	Colour
100mtr	Black

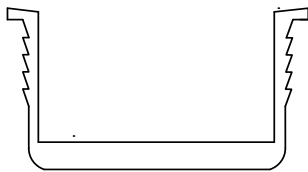

CFH94 - 20mm Glazing Channel

Length	Colour
100mtr	Black

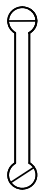

CFH95 - Drain Flap

Length	Colour
300mtr	Black



CFH96 - Male/Female Bulb Seal

Length	Colour
300mtr	Black

Please note: Images are not to scale

76mm & 101.6mm SLIDING WINDOW

HARDWARE ITEMS (MOHAIR & ACCESSORIES)



CFH80 - 6.7 x 4.25 x 4.25 Finseal

(Heights)

Length	Colour
450mtr	Black



CFH81 - 6.7 x 5.5 x 5.75 Finseal

(Head & Sill Track)

Length	Colour
400mtr	Black

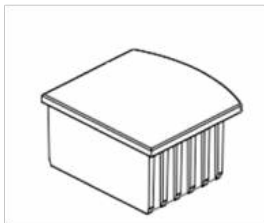

CFH113 - Boxed Interlock End Cap (Top & Bottom)

QTY	Colour
10pr per bag	Black



CFH18 - 10mm Hole Plug

QTY	Colour
100 per bag	Black



CFH115 - Drain Slot Plugs

QTY	Colour
50pcs per bag	Black

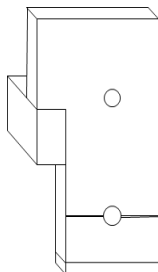

CFH110 - Fixed Panel Blocks (Left & Right)

QTY	Colour
20pr per bag	Black

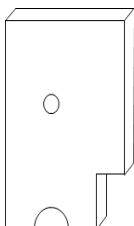

CFH111 - Sliding Panel Face Blocks (Left & Right)

QTY	Colour
20pr per bag	Black

Please note: Images are not to scale

76mm & 101.6mm SLIDING WINDOW

HARDWARE ITEMS & ACCESSORIES

CFH38D - 80kg Double Wheel Roller

(2 per moving sash)



QTY

EACH

CFH37 - 40kg Single Wheel Roller

(2 per moving sash)



QTY

EACH

CFH40 - Fixed Panel Adjustment Block

(2 per fixed sash)



QTY

EACH

CFH97 - Sliding Window Lock (Keyed)

(1 per door)



QTY

EACH

Please note: Images are not to scale

101.6mm & 150mm APARTMENT DOOR

101.6mm Apartment Door

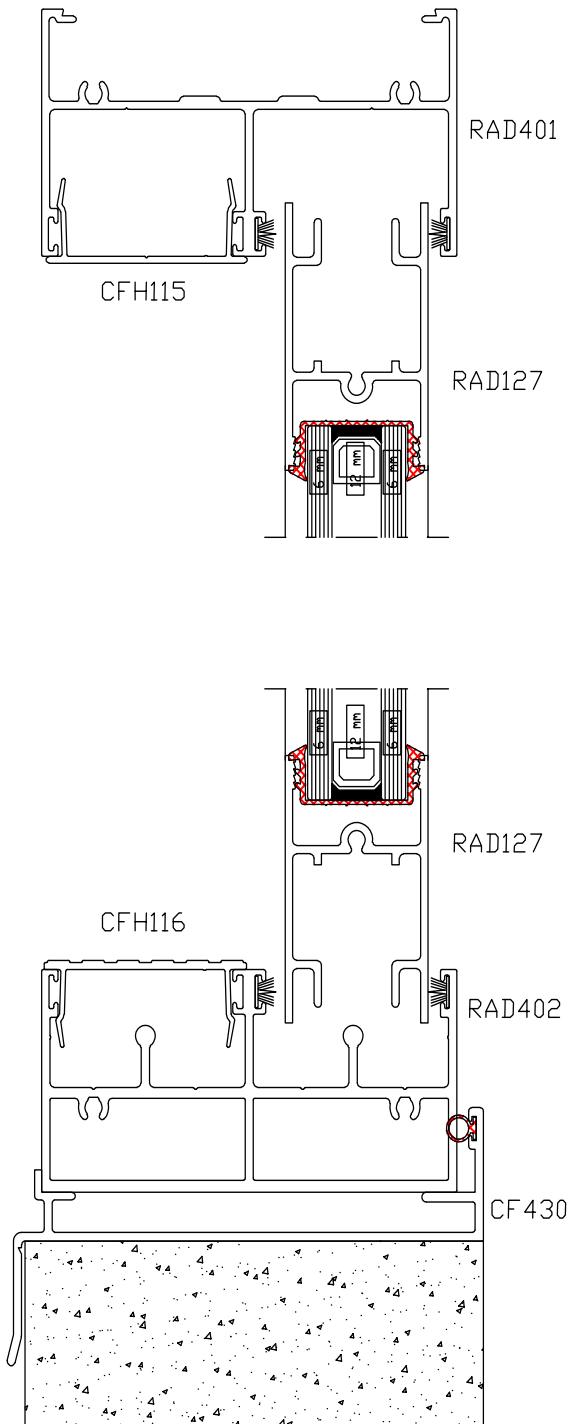

150mm Apartment Door

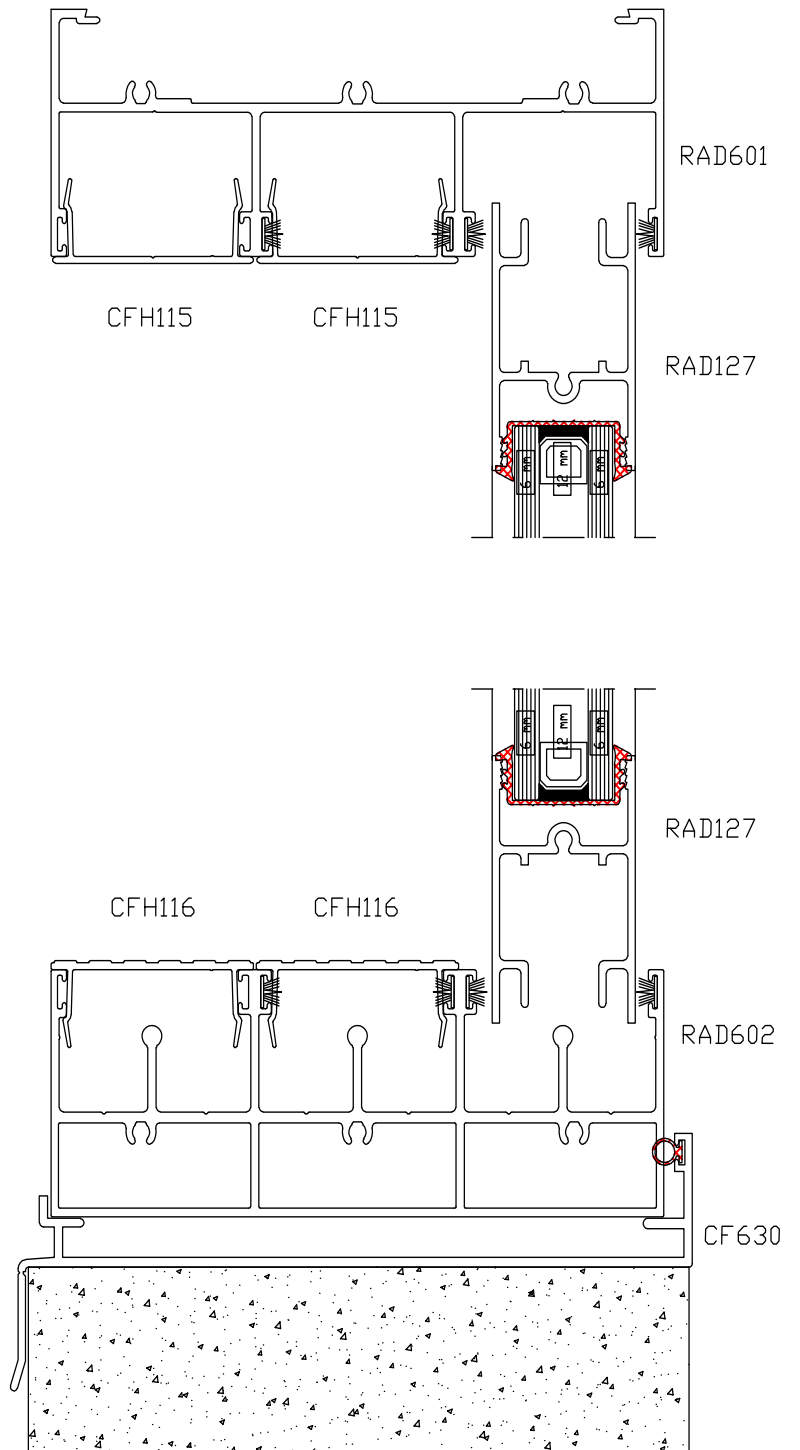

OUR NEW 30.5mm LOW PROFILE SILL TRACK IS AVAILABLE IN BOTH 100mm & 150mm SYSTEMS.

101.6mm & 150mm APARTMENT DOOR

HEAD & SILL TRACKS

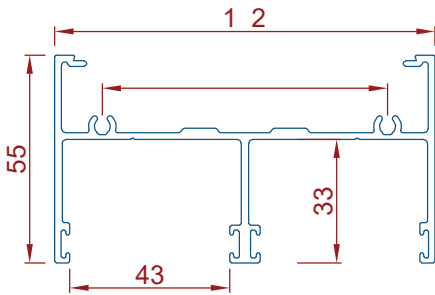

RAD401 - Head Track (Double)

(Accepts: BW404, BW444, CF405, CF470, RAD115 & ALL 4" Fixing Reveals) (Accepts: **CFH122**)

Length	Offered Finishes
6.5mtr	Mill / Natural Anodised / Powdercoated

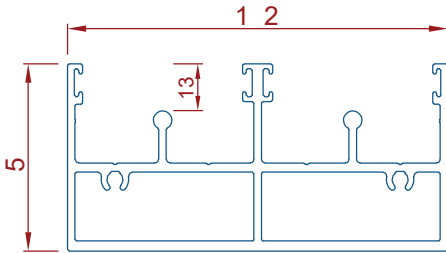

RAD402 - Sill Track 50mm (Slotted)

(Accepts: RAD115, RAD116) (Accepts: **CFH122**)

Length	Offered Finishes
6.5mtr	Mill / Natural Anodised / Powdercoated

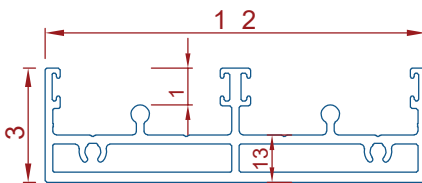

RAD404 - Sill Track 30mm (Slotted)

(Accepts: RAD115, RAD116) (Accepts: **CFH122**)

Length	Offered Finishes
6.5mtr	Mill / Natural Anodised / Powdercoated

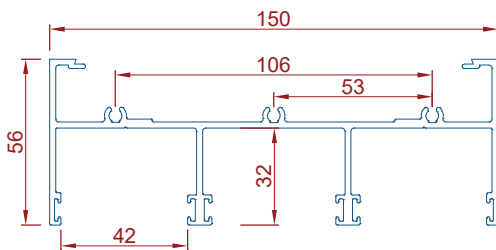

RAD601 - Head Track (Triple)

(Accepts: RA265, RAD115) (Accepts: **CFH122**)

Length	Offered Finishes
6.5mtr	Mill / Natural Anodised / Powdercoated

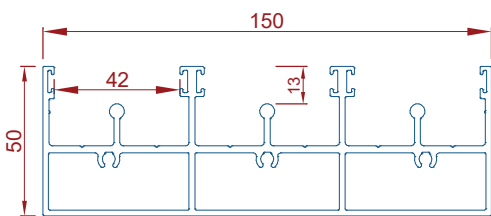

RAD605 - Sill Track 50mm (Slotted)

(Accepts: RAD115, RAD116) (Accepts: **CFH122**)

Length	Offered Finishes
6.5mtr	Mill / Natural Anodised / Powdercoated

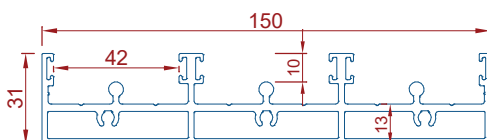

RAD604 - Sill Track 30mm (Slotted)

(Accepts: RAD115, RAD116) (Accepts: **CFH122**)

Length	Offered Finishes
6.5mtr	Mill / Natural Anodised / Powdercoated

Please note: Images are not to scale

101.6mm & 150mm APARTMENT DOOR

JAMBS

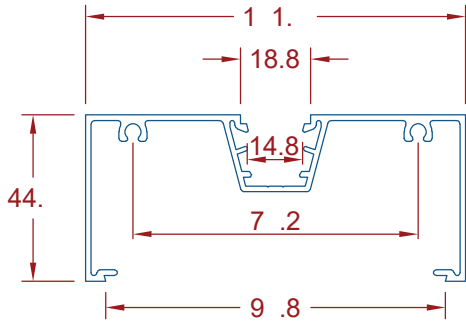

BW400 - Standard Frame (101.6 x 44.4)

(Accepts: BW404, BW444, CF405, CF406, CF470, RAD131 & ALL 4" Fixing Reveal Adaptors)

Length	Offered Finishes
6.5mtr	Mill / Natural Anodised / Powdercoated

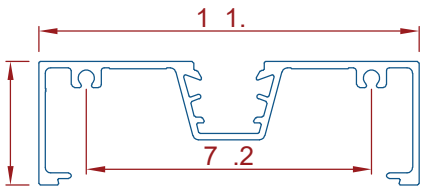

CF450 - 33mm Standard Frame (101.6 x 33)

(Accepts: CF405, CF406, CF470, RAD131)

Length	Offered Finishes
6.5mtr	Mill / Natural Anodised / Powdercoated

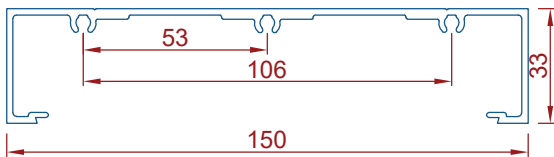

RAD603 - 150mm Plain Jamb (150 x 33)

(Accepts: RA265) To be used with RAD130

Length	Offered Finishes
6.5mtr	Mill / Natural Anodised / Powdercoated

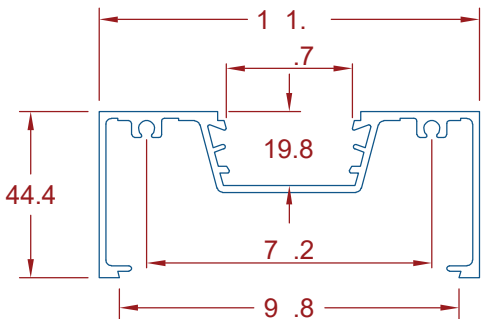

CF701 - Main Frame DG (101.6 x 44.4)

(Accepts: BW404, BW444, CF405, CF470, CF704, CF706 & ALL 4" Fixing Reveal Adaptors) **CF706 + RAD130 required**

Length	Offered Finishes
6.5mtr	Mill / Natural Anodised / Powdercoated

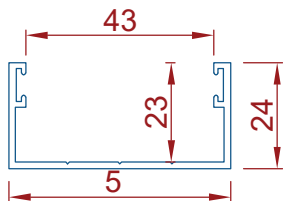

RAD130 - Jamb Receiver

(To be face fixed to flat jambs)

(Accepts: **CFH121**)

Length	Offered Finishes
6.5mtr	Mill / Natural Anodised / Powdercoated

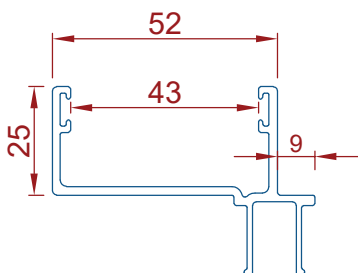

RAD131 - Clip in Jamb Receiver

(To be used with BW400 & CF450)

(Accepts: **CFH121**)

Length	Offered Finishes
6.5mtr	Mill / Natural Anodised / Powdercoated

Please note: Images are not to scale

101.6mm & 150mm APARTMENT DOOR

SINGLE GLAZED STILES & RAIL (16mm POCKET)

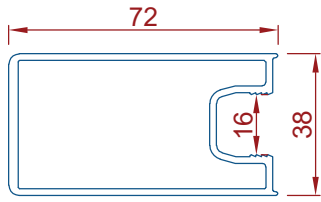

RAD105 - SG 72mm Plain Stile

(Accepts: 6mm-12.76mm Glass)

Length	Offered Finishes
6.5mtr	Mill / Natural Anodised / Powdercoated

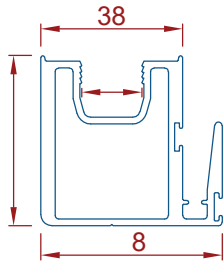

RAD106 - SG Std Interlock

(Accepts: 6mm-12.76mm Glass)

(Accepts: CFH121)

Length	Offered Finishes
6.5mtr	Mill / Natural Anodised / Powdercoated

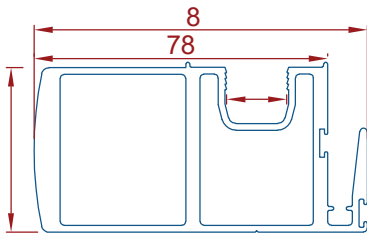

RAD107 - SG Medium Boxed Interlock

(Accepts: 6mm-12.76mm Glass)

(Accepts: CFH121)

Length	Offered Finishes
6.5mtr	Mill / Natural Anodised / Powdercoated

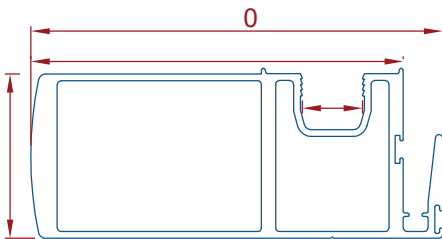

RAD108 - SG HD Boxed Interlock

(Accepts: 6mm-12.76mm Glass)

(Accepts: CFH121)

Length	Offered Finishes
6.5mtr	Mill / Natural Anodised / Powdercoated

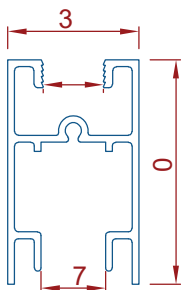

RAD112 - SG 60mm Rail

(Accepts: 6mm-12.76mm Glass)

Length	Offered Finishes
6.5mtr	Mill / Natural Anodised / Powdercoated

Please note: Images are not to scale

101.6mm & 150mm APARTMENT DOOR

DOUBLE GLAZED STILES & RAIL (30mm POCKET)

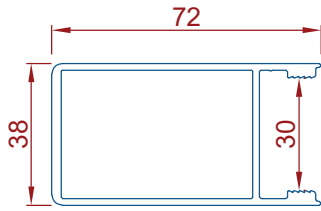

RAD120 - DG 72mm Plain Stile

(Accepts: 24mm-26mm IGU)

Length	Offered Finishes
6.5mtr	Mill / Natural Anodised / Powdercoated

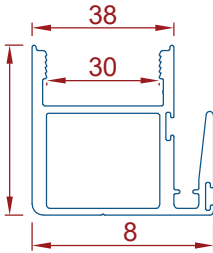

RAD121 - DG Std Interlock

(Accepts: 24mm-26mm IGU)

(Accepts: **CFH121**)

Length	Offered Finishes
6.5mtr	Mill / Natural Anodised / Powdercoated

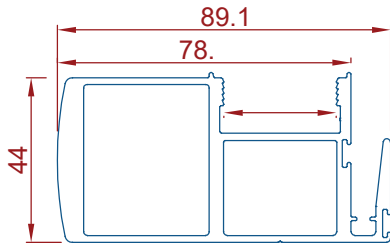

RAD122 - DG Medium Boxed Interlock

(Accepts: 24mm-26mm IGU)

(Accepts: **CFH121**)

Length	Offered Finishes
6.5mtr	Mill / Natural Anodised / Powdercoated

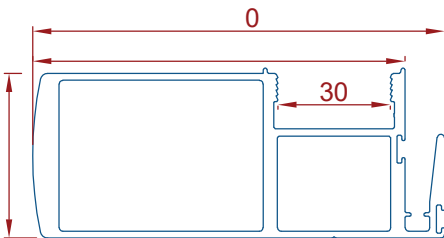

RAD123 - DG HD Boxed Interlock

(Accepts: 24mm-26mm IGU)

(Accepts: **CFH121**)

Length	Offered Finishes
6.5mtr	Mill / Natural Anodised / Powdercoated

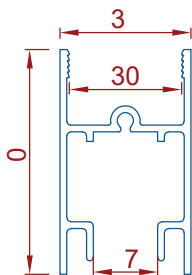

RAD127 - DG 60mm Rail

(Accepts: 24mm-26mm IGU)

Length	Offered Finishes
6.5mtr	Mill / Natural Anodised / Powdercoated

Please note: Images are not to scale

101.6mm & 150mm APARTMENT DOOR

BEADED RAIL AND CORNER STILES

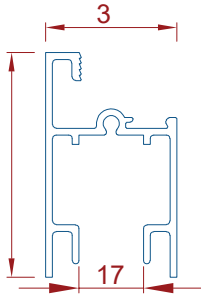

RAD113 - SG 60mm Beaded Rail

(Accepts: RAD114 Bead & 6mm-12.76mm Glass)

Length	Offered Finishes
6.5mtr	Mill / Natural Anodised / Powdercoated

RAD114 - SG Bead

(Accepts: RAD113 SG Rail)

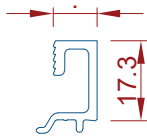

Length	Offered Finishes
6.5mtr	Mill / Natural Anodised / Powdercoated

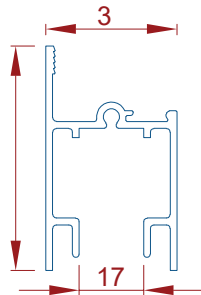

RAD128 - DG 60mm Beaded Rail

(Accepts: RAD129 Bead & 24mm-26mm IGU)

Length	Offered Finishes
6.5mtr	Mill / Natural Anodised / Powdercoated

RAD129 - DG Bead

(Accepts: RAD128 DG Rail)



Length	Offered Finishes
6.5mtr	Mill / Natural Anodised / Powdercoated

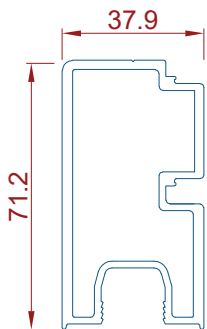

RAD117 - 71mm SG Corner Stile

(Accepts: RAD110 Female Stile & 6mm-12.76mm Glass)

Length	Offered Finishes
6.5mtr	Mill / Natural Anodised / Powdercoated

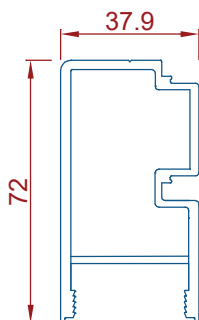

RAD118 - 71mm DG Corner Stile

(Accepts: RAD125 Female Stile & 24mm-26mm Glass)

Length	Offered Finishes
6.5mtr	Mill / Natural Anodised / Powdercoated

Please note: Images are not to scale

101.6mm & 150mm APARTMENT DOOR

MALE & FEMALE STILES SG & DG (BI-PARTING)

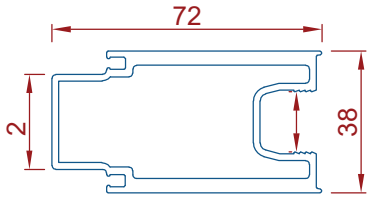

RAD109 - SG 72mm Male Stile

(6mm-12.76mm Glass)

(Accepts: **CFH96**)

Length	Offered Finishes
6.5mtr	Mill / Natural Anodised / Powdercoated

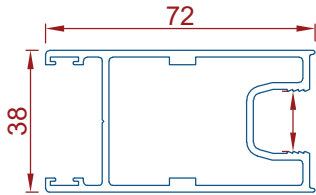

RAD110 - SG Female Stile

(Accepts: 6mm-12.76mm Glass)

(Accepts: **CFH121**)

Length	Offered Finishes
6.5mtr	Mill / Natural Anodised / Powdercoated

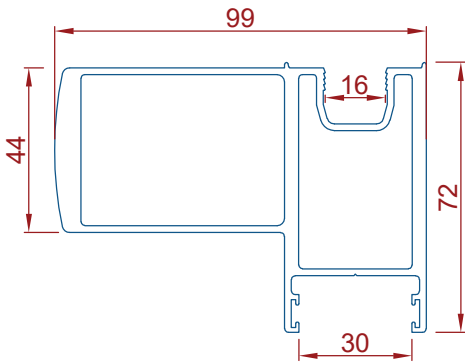

RAD111 - SG H/D Boxed Female Stile

(Accepts: 6mm-12.76mm Glass)

(Accepts: **CFH121**)

Length	Offered Finishes
6.5mtr	Mill / Natural Anodised / Powdercoated

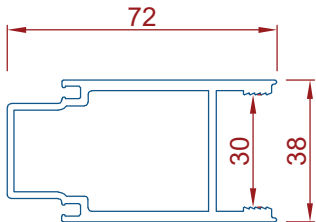

RAD124 - DG 72mm Male Stile

(Accepts: 24mm-26mm IGU)

(Accepts: **CFH96**)

Length	Offered Finishes
6.5mtr	Mill / Natural Anodised / Powdercoated

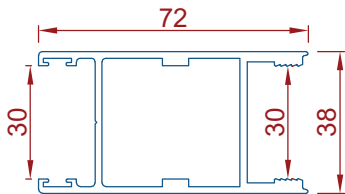

RAD125 - DG Female Stile

(Accepts: 24mm-26mm IGU)

(Accepts: **CFH121**)

Length	Offered Finishes
6.5mtr	Mill / Natural Anodised / Powdercoated

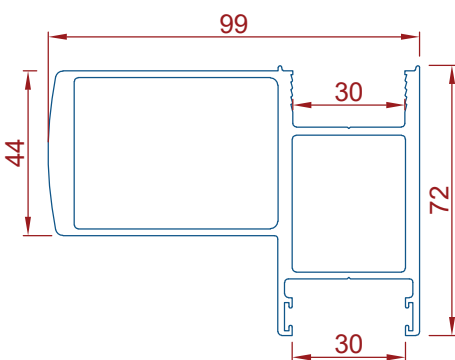

RAD126 - DG H/D Boxed Female Stile

(Accepts: 24mm-26mm IGU)

(Accepts: **CFH121**)

Length	Offered Finishes
6.5mtr	Mill / Natural Anodised / Powdercoated

Please note: Images are not to scale

101.6mm & 150mm APARTMENT DOOR

FLAT FILLERS, THRESHOLDS & ADAPTORS

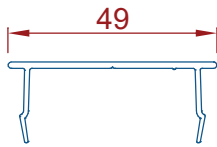

RAD115 - Flat Filler (Head Track)

Accepts: RAD130, RAD131, RAD401, RAD601)

Length	Offered Finishes
6.5mtr	Mill / Natural Anodised / Powdercoated

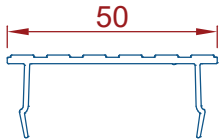

RAD116 - Threshold

(Accepts: RAD402, RAD404, RAD602, RAD604)

Length	Offered Finishes
6.5mtr	Mill / Natural Anodised / Powdercoated

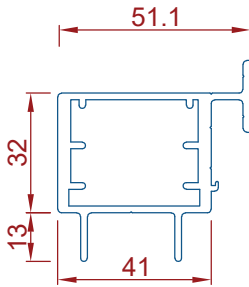

RA131 - OXO Adaptor

(To be used with F/S/F doors)

Length	Offered Finishes
6.5mtr	Mill / Natural Anodised / Powdercoated

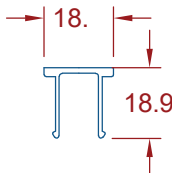

CF406 - Pocket Filler

(To be used with BW400 & CF450)

Length	Offered Finishes
6.5mtr	Mill / Natural Anodised / Powdercoated

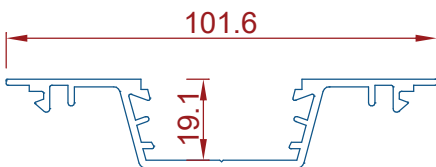

CF705 - DG Highlight Adaptor

(Accepts: RAD401 & RSD501)

Length	Offered Finishes
6.5mtr	Mill / Natural Anodised / Powdercoated

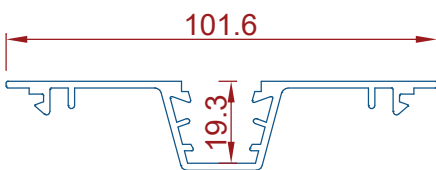

CF452 - SG Highlight Adaptor

(Accepts: RAD401 & RSD501)

Length	Offered Finishes
6.5mtr	Mill / Natural Anodised / Powdercoated

Please note: Images are not to scale

101.6mm & 150mm APARTMENT DOOR

SUBSILLS

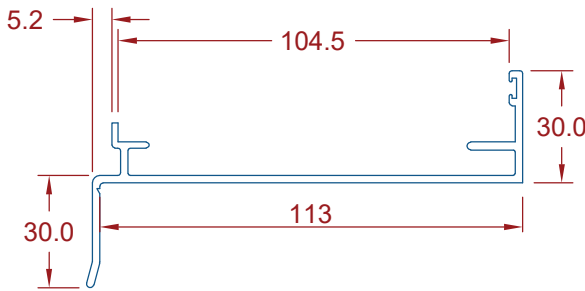

CF430 - 113mm Slotted Subsill (5.2mm setback)

(Accepts: 101.6mm Thresholds, **CFH13**, **CFH13D**)

Length	Offered Finishes
6.5mtr	Mill / Natural Anodised / Powdercoated

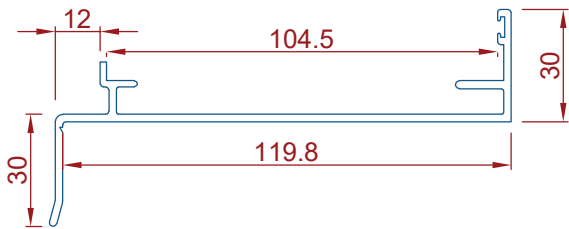

CF420 - 120mm Slotted Subsill (12mm setback)

(Accepts: 101.6mm Thresholds, **CFH13**, **CFH13D**)

Length	Offered Finishes
6.5mtr	Mill / Natural Anodised / Powdercoated

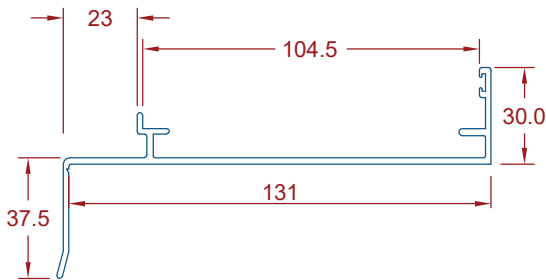

CF431R - 131mm Slotted Subsill (23mm setback)

(Accepts: 101.6mm Thresholds, **CFH13**, **CFH13D**)

Length	Offered Finishes
6.5mtr	Mill / Natural Anodised / Powdercoated

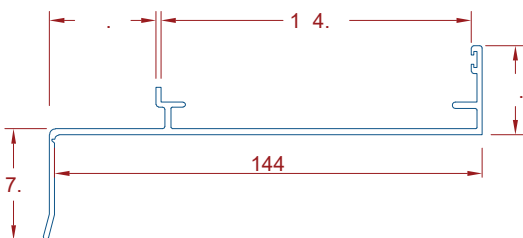

CF462 - 144mm Slotted Subsill (36mm setback)

(Accepts: 101.6mm Thresholds, **CFH13**, **CFH13D**)

Length	Offered Finishes
6.5mtr	Mill / Natural Anodised / Powdercoated

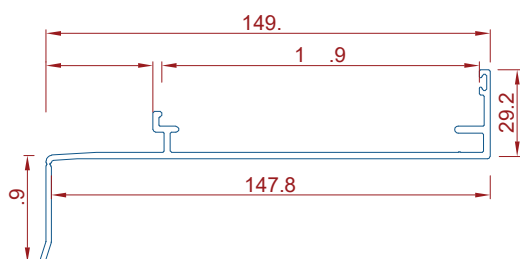

CF462N - 148mm Slotted Subsill (36mm setback)

(Accepts: 101.6mm Thresholds, **CFH13**, **CFH13D**)

Length	Offered Finishes
6.5mtr	Mill / Natural Anodised / Powdercoated

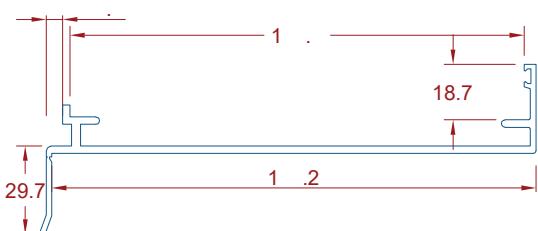

CF630 - 150mm Slotted Subsill (6mm setback)

(Accepts: **CFH13** & **CFH13D**) Suits 150mm Frame

Length	Offered Finishes
6.5mtr	Mill / Natural Anodised / Powdercoated

Please note: Images are not to scale

101.6mm & 150mm APARTMENT DOOR

SUBHEADS & SUB JAMBS

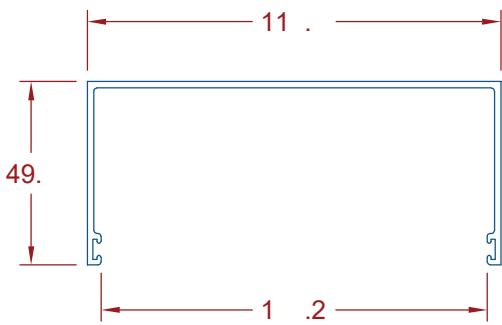

CF437 - Standard Subhead (110mm x 49mm)

(Accepts: **CFH13** & **CFH13D**)

Length	Offered Finishes
6.5mtr	Mill / Natural Anodised / Powdercoated

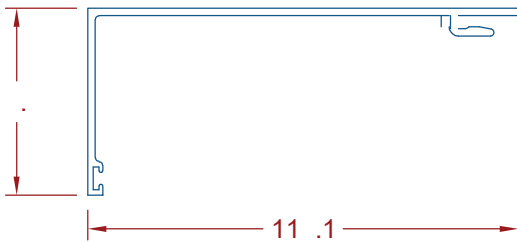

CF458 - 2 Piece Subhead (115mm x 50mm)

(Accepts: CF457)

(Accepts: **CFH13** & **CFH13D**)

Length	Offered Finishes
6.5mtr	Mill / Natural Anodised / Powdercoated

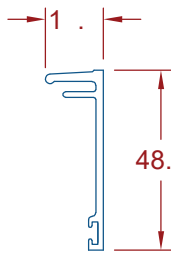

CF457 - 2 Piece Subhead Cover (Pressure Bead)

(Accepts: CF458, CF658)

(Accepts: **CFH13** & **CFH13D**)

Length	Offered Finishes
6.5mtr	Mill / Natural Anodised / Powdercoated

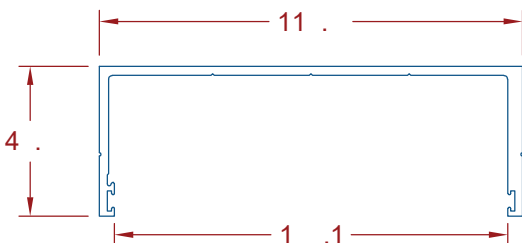

CF477 - Heavy Duty Subhead (113mm x 40mm)

(Accepts: 101.6mm Frames)

(Accepts: **CFH13** & **CFH13D**)

Length	Offered Finishes
6.5mtr	Mill / Natural Anodised / Powdercoated

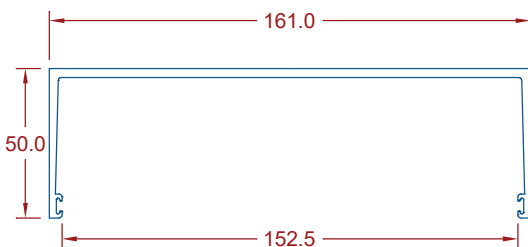

CF637 - 150mm Subhead

(Accepts: **CFH13** & **CFH13D**) Suits 150mm Frame

Length	Offered Finishes
6.5mtr	Mill / Natural Anodised / Powdercoated

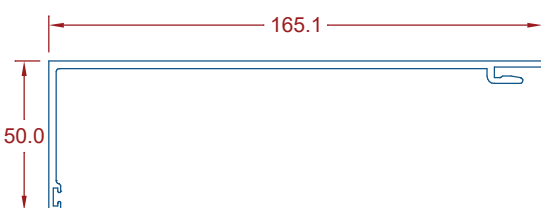

CF658 - 150mm Subhead 2 Piece

(Accepts: CF457) Suits 150mm Frame

(Accepts: **CFH13** & **CFH13D**)

Length	Offered Finishes
6.5mtr	Mill / Natural Anodised / Powdercoated

Please note: Images are not to scale

101.6mm & 150mm APARTMENT DOOR

HARDWARE ITEMS (GLAZING CHANNEL)

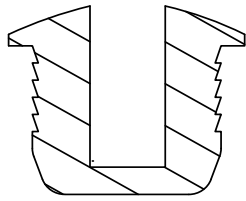

CFH90 - 6mm-6.76mm Glazing Channel

Length	Colour
100mtr	Black

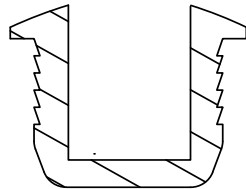

CFH92 - 10mm-10.76mm Glazing Channel

Length	Colour
100mtr	Black

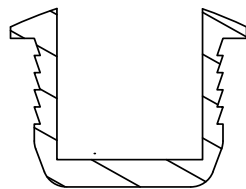

CFH93 - 12mm-12.76mm Glazing Channel

Length	Colour
100mtr	Black

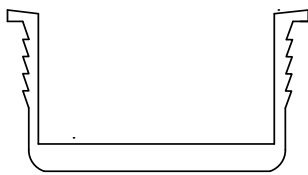

CFH94 - 20mm Glazing Channel

Length	Colour
80mtr	Black

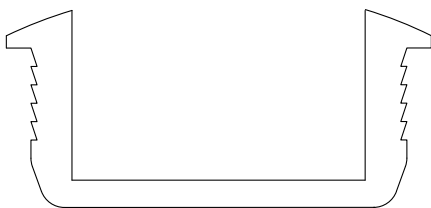

CFH29 - 24mm-25mm Glazing Channel

Length	Colour
50mtr	Black



CFH124 - 26mm Glazing Channel

Length	Colour
50mtr	Black

Please note: Images are not to scale

101.6mm & 150mm APARTMENT DOOR

HARDWARE ITEMS (MOHAIR & ACCESSORIES)



CFH121 - 6.9 x 6.5 Std Finseal

(Heights)

Length	Colour
350mtr	Black



CFH122 - 6.9 x 6.5 High Finseal

(Head & Sill Track)

Length	Colour
250mtr	Black



CFH96 - Male/Female Bulb Seal

QTY	Colour
200mtr	Black

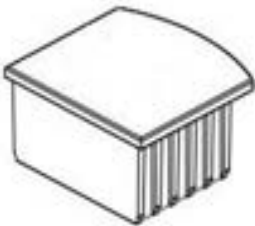

CFH119 - Med Box End Cap (Med Interlock)

(Top & Bottom = 1pr)

QTY	Colour
10pr per bag	Black

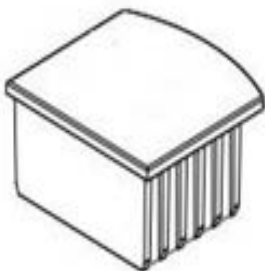

CFH120 - Large Box End Cap (Large interlock)

(Top & Bottom = 1pr)

QTY	Colour
10pr per bag	Black



CFH18 - 10mm Hole Plug

QTY	Colour
100 per bag	Black



CFH115 - Drain Slot Plug

QTY	Colour
50 per bag	Black

Please note: Images are not to scale

101.6mm & 150mm APARTMENT DOOR

HARDWARE ITEMS (ACCESSORIES)

CFH118 - Threshold / Header Filler Rubber End Stop

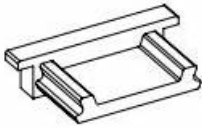

(Accepts: RAD115 & RAD116)

QTY	Colour
50 per bag	Black

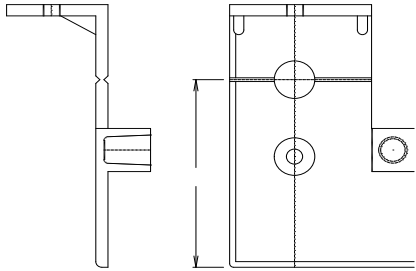

CFH116 - Fixed Panel Blocks (Left & Right)

(1 x pair = top & bottom of fixed panel)

QTY	Colour
20 prs per bag	Black

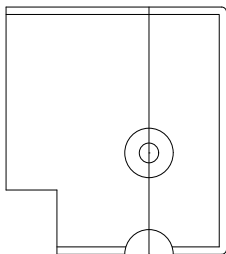

CFH117 - Sliding Panel Blocks (Left & Right)

(1 x pair = top & bottom of fixed panel)

QTY	Colour
20 prs per bag	Black

CFH38D - 80kg Double Wheel Roller

(2 per moving sash)



QTY
Each

CFH37 - 40kg Single Wheel Roller

(2 per moving sash)



QTY
Each

CFH40 - Fixed Panel Adjustment Block

(2 per fixed sash)



QTY
Each

FOAM TABS

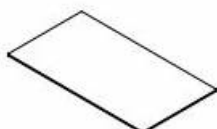

CFH104 = RAD402 / CFH108 = RAD401 / CFH109 = RAD601 & 602

QTY PER ROLL
CFH104 = 980pcs / CFH108 = 890pcs / CFH109 = 890pcs

Please note: Images are not to scale

101.6mm & 150mm APARTMENT DOOR

HARDWARE ITEMS (ACCESSORIES)



CFH98 - D Lock Sliding Door Handle

QTY	Colour
EACH	Black



CFH99 - Slimline Sliding Door Handle

QTY	Colour
EACH	Black

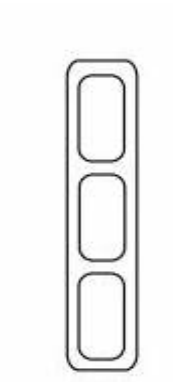

CFH123 - Packer

QTY	Colour
EACH	Black

Please note: Images are not to scale

101.6mm & 165mm SEMI-COMMERCIAL DOOR

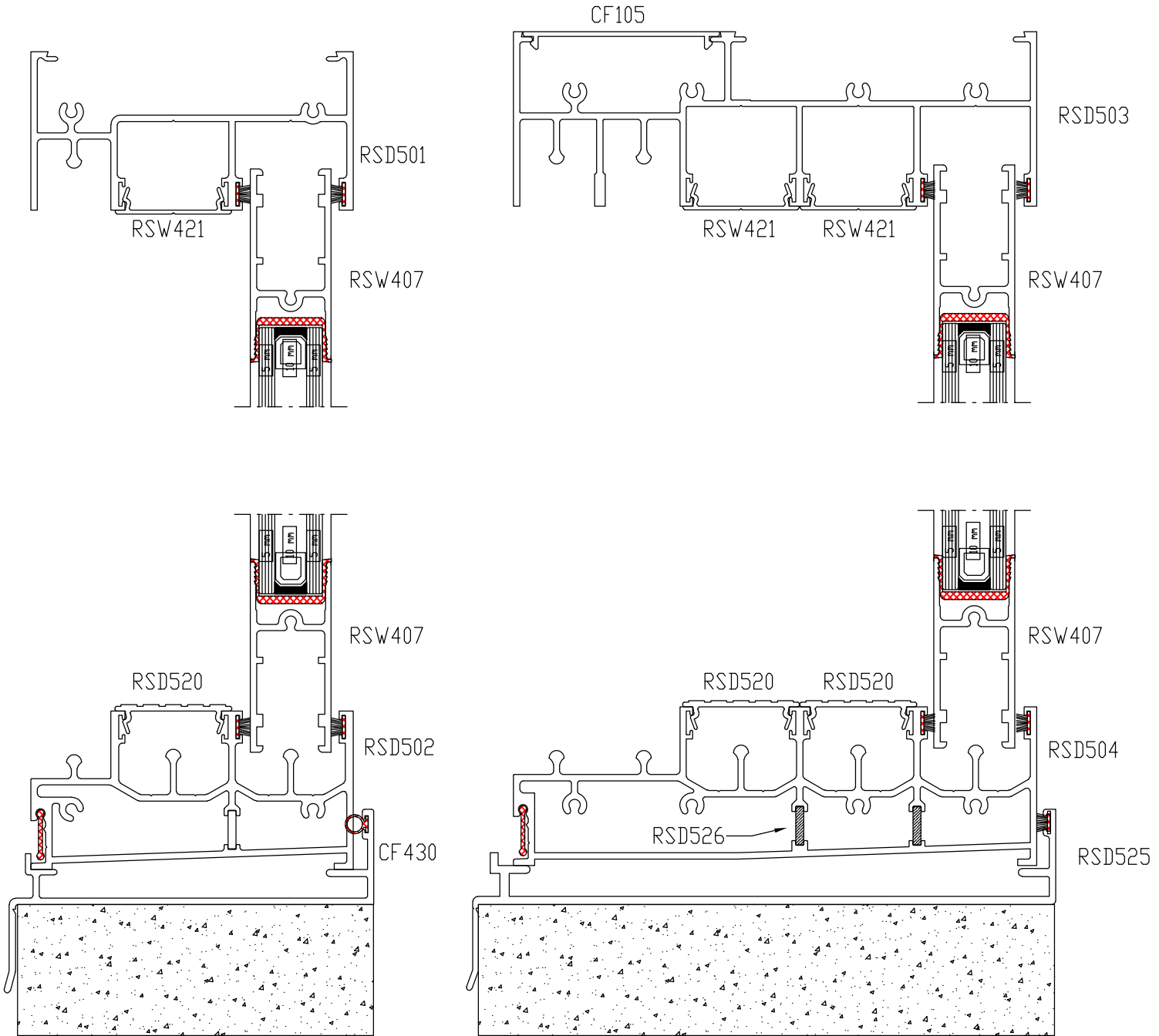

Please note: Images are not to scale

101.6mm & 165mm SEMI-COMMERCIAL DOOR

HEAD, SILL TRACK & SUBFRAME

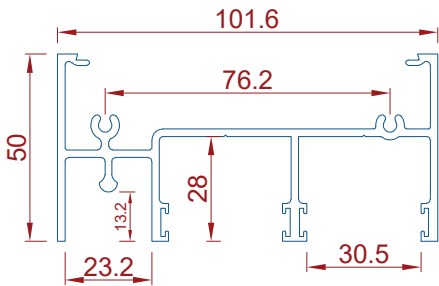

RSD501 - 101.6mm Head Track

(Accepts: BW404, BW444, CF405, CF470, RSW421 & ALL 4" Fixing Reveals) (Accepts: **CFH81**)

Length	Offered Finishes
6.5mtr	Mill / Natural Anodised / Powdercoated

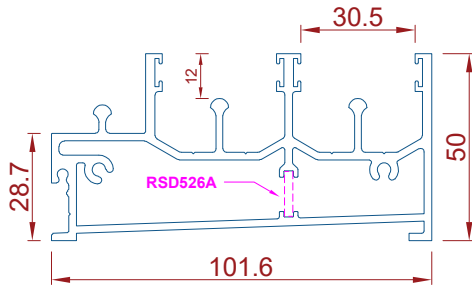

RSD502 - 101.6mm Sill Track

(Accepts: RSD520, RSW406, RSW407) (Accepts: **CFH81**)

Length	Offered Finishes
6.5mtr	Mill / Natural Anodised / Powdercoated

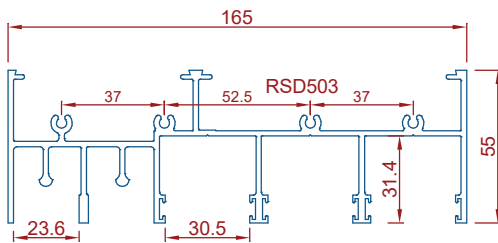

RSD503 - 165mm Head Track

(Accepts: BW404, BW444, CF105, CF405, CF470, RSW421 & ALL 4" Fixing Reveals) (Accepts: **CFH81**)

Length	Offered Finishes
6.5mtr	Mill / Natural Anodised / Powdercoated

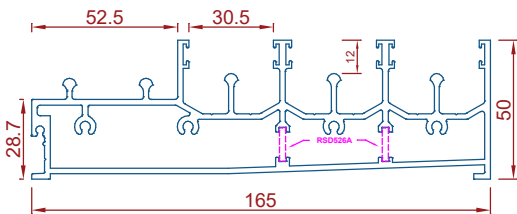

RSD504 - 165mm Sill Track

(Accepts: RSD520, RSW406, RSW407) (Accepts: **CFH81**)

Length	Offered Finishes
6.5mtr	Mill / Natural Anodised / Powdercoated

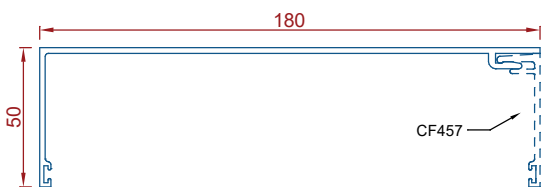

RSD524 - 165mm 2 Part Subhead

(USE CF457 BEAD & Accepts: RSD503) (Accepts: **CFH13** & **CFH13D**)

Length	Offered Finishes
5.4mtr	Mill / Natural Anodised / Powdercoated

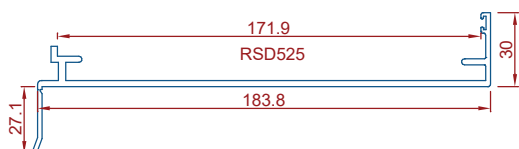

RSD525 - 165mm Subsill

(Accepts: RSD504) (Accepts: **CFH13** & **CFH13D**)

Length	Offered Finishes
5.4mtr	Mill / Natural Anodised / Powdercoated

Please note: Images are not to scale

101.6mm & 165mm SEMI-COMMERCIAL DOOR

JAMBS

BW400 - Standard Frame

(Accepts: CF406 + RSW404)

Length	Offered Finishes
6.5mtr	Mill / Natural Anodised / Powdercoated

RSW404 - 101.6mm Double Receiver Channel

(Accepts: BW400 with CF406 & CFH80)

Length	Offered Finishes
5.4mtr	Mill / Natural Anodised / Powdercoated

RSD505 - 165mm Jamb

(Accepts: CF105, CF405, RSD506, RSD507)

Length	Offered Finishes
5.5mtr	Mill / Natural Anodised / Powdercoated

RSD506 - 165mm Jamb Receiver

(Accepts: RSD505 & CFH80)

Length	Offered Finishes
5.4mtr	Mill / Natural Anodised / Powdercoated

RSD507 - 165mm Jamb Double Flyscreen Receiver

(Accepts: RSD505)

Length	Offered Finishes
5.4mtr	Mill / Natural Anodised / Powdercoated

RSD508 - 101.6mm Jamb Single Flyscreen Receiver

(Accepts: 101.6mm Jamb)

Length	Offered Finishes
5.4mtr	Mill / Natural Anodised / Powdercoated

RSD515 - Clip In Receiver

(Clips into BW400 series pockets & accepts CFH80)

Length	Offered Finishes
5.4mtr	Mill / Natural Anodised / Powdercoated

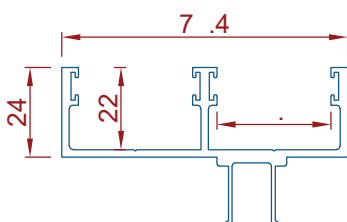
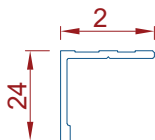
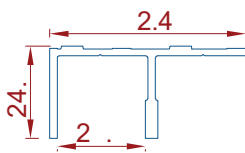
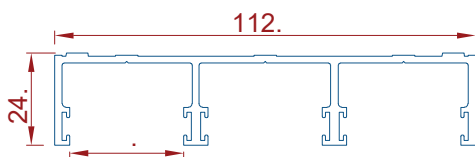
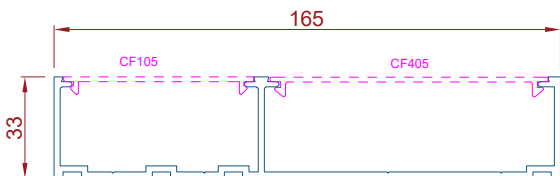
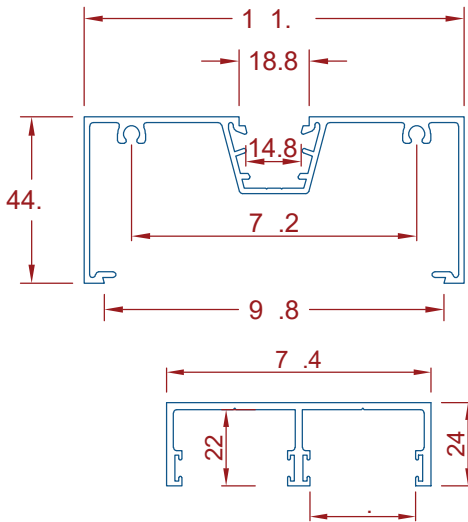

Please note: Images are not to scale

101.6mm & 165mm SEMI-COMMERCIAL DOOR

SINGLE GLAZE STILES & RAILS TO SUIT 6mm - 12.76mm GLASS

RSW408 - SG Lock Stile (16mm Pocket)

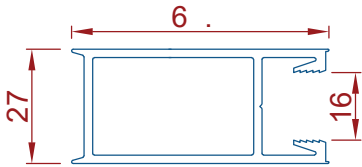

(Accepts: 6mm to 12.76mm Glass)

Length	Offered Finishes
5.4mtr	Mill / Natural Anodised / Powdercoated

RSW410 - SG Standard Interlock (16mm Pocket)

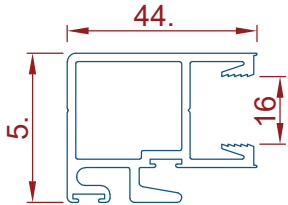

(Accepts: CFH80, 6mm to 12.76mm Glass)

Length	Offered Finishes
5.4mtr	Mill / Natural Anodised / Powdercoated

RSW412 - SG Boxed Interlock (16mm Pocket)

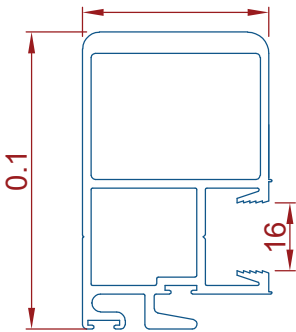

(Accepts: CFH80, 6mm to 12.76mm Glass)

Length	Offered Finishes
5.4mtr	Mill / Natural Anodised / Powdercoated

RSW406 - SG Rail (16mm Pocket)

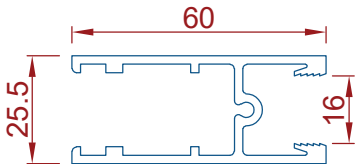

(Accepts: 6mm to 12.76mm Glass)

Length	Offered Finishes
5.1mtr	Mill / Natural Anodised / Powdercoated

RSW418 - SG Male Meeting Stile (16mm Pocket)

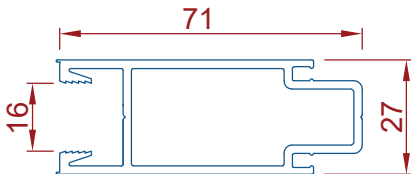

(Accepts: CFH96, 6mm to 12.76mm Glass)

Length	Offered Finishes
5.4mtr	Mill / Natural Anodised / Powdercoated

RSW414 - SG Female Meeting Stile (16mm Pocket)

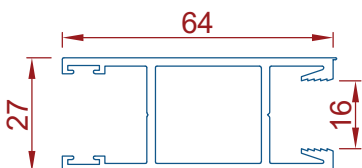

(Accepts: CFH80, 6mm to 12.76mm Glass)

Length	Offered Finishes
5.4mtr	Mill / Natural Anodised / Powdercoated

Please note: Images are not to scale

101.6mm & 165mm SEMI-COMMERCIAL DOOR

SINGLE GLAZED STILES, FLYDOOR INTERLOCKS & FILLERS

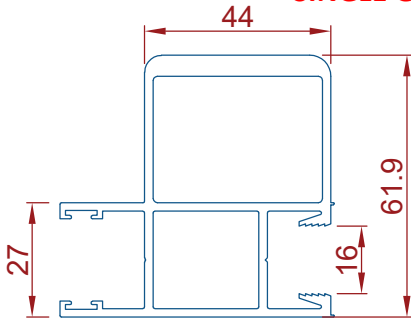

RSW416 - SG Med Boxed Female Meeting Stile

(Accepts: **CFH80**, 6mm to 12.76mm Glass)

Length	Offered Finishes
5.4mtr	Mill / Natural Anodised / Powdercoated

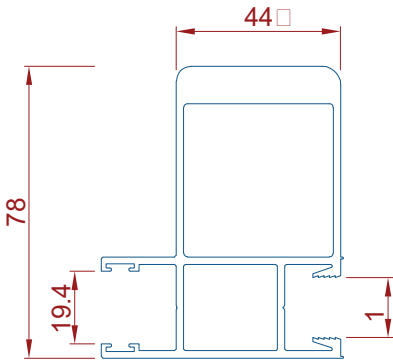

RSD513 - SG HD Boxed Female Meeting Stile

(Accepts: **CFH80**, 6mm to 12.76mm Glass)

Length	Offered Finishes
5.4mtr	Mill / Natural Anodised / Powdercoated

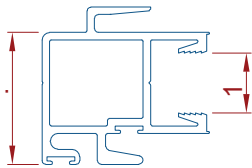

RSD509 - SG Fly Door Std Interlock

(Accepts: **CFH80**)

Length	Offered Finishes
5.4mtr	Mill / Natural Anodised / Powdercoated

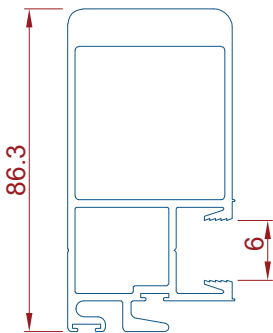

RSD511 - SG Fly Door HD Interlock

(Accepts: **CFH80**)

Length	Offered Finishes
5.4mtr	Mill / Natural Anodised / Powdercoated

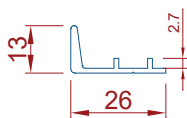

RSD528 - Security Door Interlock (Plant On)

(Accepts: RSD527)

Length	Offered Finishes
5.4mtr	Mill / Natural Anodised / Powdercoated

Please note: Images are not to scale

101.6mm & 165mm SEMI-COMMERCIAL DOOR

DOUBLE GLAZED STILES & RAILS TO SUIT 20mm IGU'S

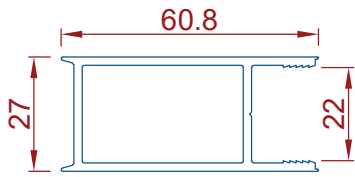

RSW409 - DG Lock Stile

(Accepts: 20mm IGU)

Length	Offered Finishes
5.4mtr	Mill / Natural Anodised / Powdercoated

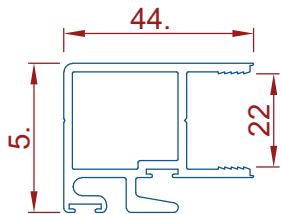

RSW411 - DG Standard Interlock

(Accepts: CFH80, 20mm IGU)

Length	Offered Finishes
5.4mtr	Mill / Natural Anodised / Powdercoated

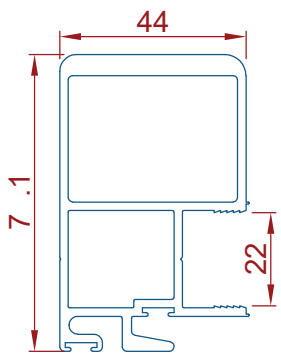

RSW413 - DG Boxed Interlock

(Accepts: CFH80, 20mm IGU)

Length	Offered Finishes
5.4mtr	Mill / Natural Anodised / Powdercoated

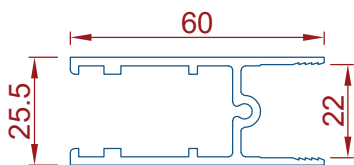

RSW407 - DG Rail

(Accepts: 20mm IGU)

Length	Offered Finishes
5.1mtr	Mill / Natural Anodised / Powdercoated

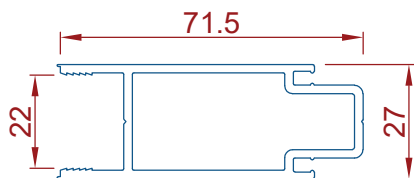

RSW419 - DG Male Meeting Stile

(Accepts: CFH96, 20mm IGU)

Length	Offered Finishes
5.1mtr	Mill / Natural Anodised / Powdercoated

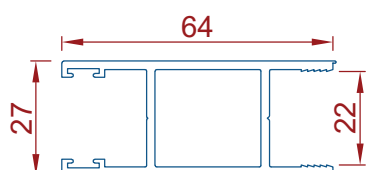

RSW415 - DG Female Meeting Stile

(Accepts: CFH80, 20mm IGU)

Length	Offered Finishes
5.4mtr	Mill / Natural Anodised / Powdercoated

Please note: Images are not to scale

101.6mm & 165mm SEMI-COMMERCIAL DOOR

DOUBLE GLAZED STILES & FLYDOOR INTERLOCKS TO SUIT 20mm IGU'S

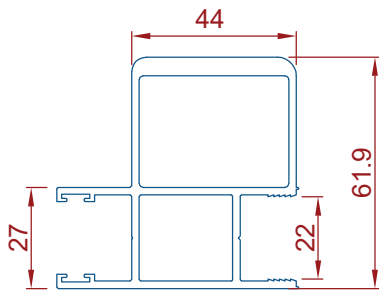

RSW417 - DG Med Boxed Female Meeting Stile

(Accepts: **CFH80**, 20mm IGU)

Length	Offered Finishes
5.4mtr	Mill / Natural Anodised / Powdercoated

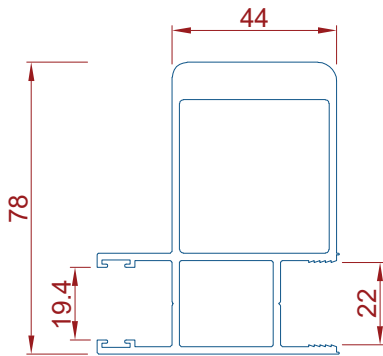

RSD514 - DG HD Boxed Female Meeting Stile

(Accepts: **CFH80**, 20mm IGU)

Length	Offered Finishes
5.4mtr	Mill / Natural Anodised / Powdercoated

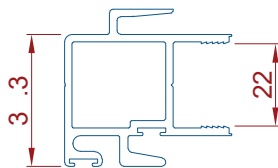

RSD510 - DG Fly Door Std Interlock

(Accepts: **CFH80**, 20mm IGU)

Length	Offered Finishes
5.4mtr	Mill / Natural Anodised / Powdercoated

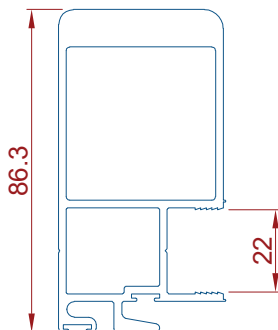

RSD512 - DG Fly Door HD Interlock

(Accepts: **CFH80**, 20mm IGU)

Length	Offered Finishes
5.4mtr	Mill / Natural Anodised / Powdercoated

Please note: Images are not to scale

101.6mm & 165mm SEMI-COMMERCIAL DOOR

MISCELLANEOUS

RSD520 - Threshold

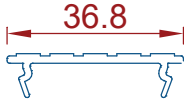

(Accepts: RSD502, RSD504)

Length	Offered Finishes
5.4mtr	Mill / Natural Anodised / Powdercoated

RSD521 - Fly Door Interlock

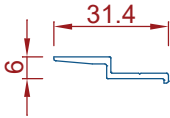

(Accepts: All RSD or RSW Interlocks))

Length	Offered Finishes
5.4mtr	Mill / Natural Anodised / Powdercoated

RSD523 - FSF Flyscreen Adaptor

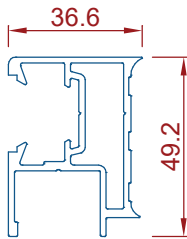

(Accepts: Boxed Interlock)

Length	Offered Finishes
5.4mtr	Mill / Natural Anodised / Powdercoated

RSD526 - Sill Track Support (Slotted)

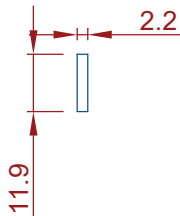

(Accepts: RSD502 & RSD504)

Length	Offered Finishes
4.0mtr	Natural Anodised

RSD527 - Security Door frame

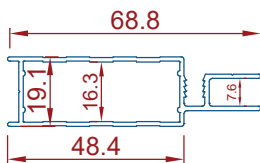

(Accepts: RSD528)

Length	Offered Finishes
6.0mtr	Mill / Natural Anodised / Powdercoated

RSW421 - Flat Filler

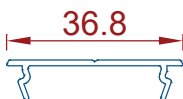

(Accepts: RSD501, RSD503, RSD506)

Length	Offered Finishes
5.4mtr	Mill / Natural Anodised / Powdercoated

Please note: Images are not to scale

101.6mm & 165mm SEMI-COMMERCIAL DOOR

HARDWARE ITEMS (RUBBERS)

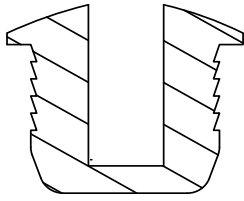

CFH90 - 6mm-6.76mm Glazing Channel

Length	Colour
80mtr	Black

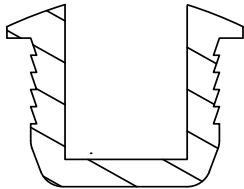

CFH92 - 10mm-10.76mm Glazing Channel

Length	Colour
100mtr	Black

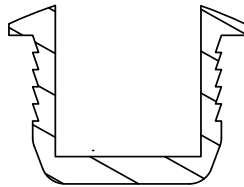

CFH93 - 12mm-12.76mm Glazing Channel

Length	Colour
100mtr	Black

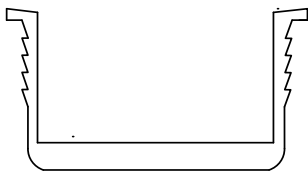

CFH94 - 20mm Glazing Channel

Length	Colour
100mtr	Black

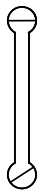

CFH95 - Drain Flap

Length	Colour
300mtr	Black



CFH96 - Male/Female Bulb Seal

Length	Colour
300mtr	Black

Please note: Images are not to scale

101.6mm & 165mm SEMI-COMMERCIAL DOOR

HARDWARE ITEMS (FIN SEALS & ACCESSORIES)



CFH80 - 6.7 x 4.25 x 4.25 Finseal

(Heights)

Length	Colour
450mtr	Black



CFH81 - 6.7 x 5.5 x 5.75 Finseal

(Head & Sill Track)

Length	Colour
400mtr	Black

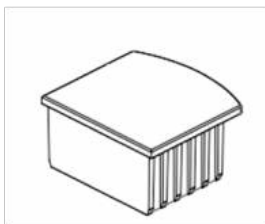

CFH113 - Boxed Interlock End Cap (Top & Bottom)

QTY	Colour
10pr per bag	Black



CFH114 - Large Boxed Interlock End Cap (Top & Bottom)

QTY	Colour
10pr per bag	Black



CFH18 - 10mm Hole Plug

QTY	Colour
10pr per bag	Black



CFH115 - Drain Slot Plugs

QTY	Colour
50pcs per bag	Black

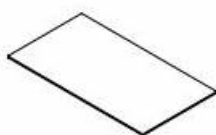

FOAM TABS

CFH104 = RSD501 / CFH105 = RSD502 / CFH106 = RSD503

CFH107 = RSD504

QTY PER ROLL
CFH104 = 980pcs / CFH108 = 890pcs / CFH109 = 890pcs

Please note: Images are not to scale

101.6mm & 165mm SEMI-COMMERCIAL DOOR

HARDWARE ITEMS (ACCESSORIES)

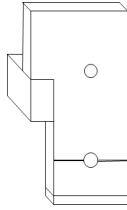

CFH110 - Fixed Panel Blocks (Left & Right)

QTY	Colour
10pr per bag	Black

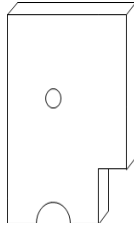

CFH111 - Sliding Panel Face Blocks (Left & Right)

QTY	Colour
10pr per bag	Black



CFH38D - 80kg Double Wheel Roller

(2 per moving sash)

QTY	Colour
EACH	



CFH37 - 40kg Single Wheel Roller

(2 per moving sash)

QTY	Colour
EACH	



CFH40 - Fixed Panel Adjustment Block

(2 per fixed sash)

QTY	Colour
EACH	



CFH98 - D Lock Sliding Door Handle

QTY	Colour
EACH	Black



CFH99 - Slimline Sliding Door Handle

QTY	Colour
EACH	Black



CFH123 - Packer

QTY	Colour
EACH	Black

Please note: Images are not to scale

NOTES

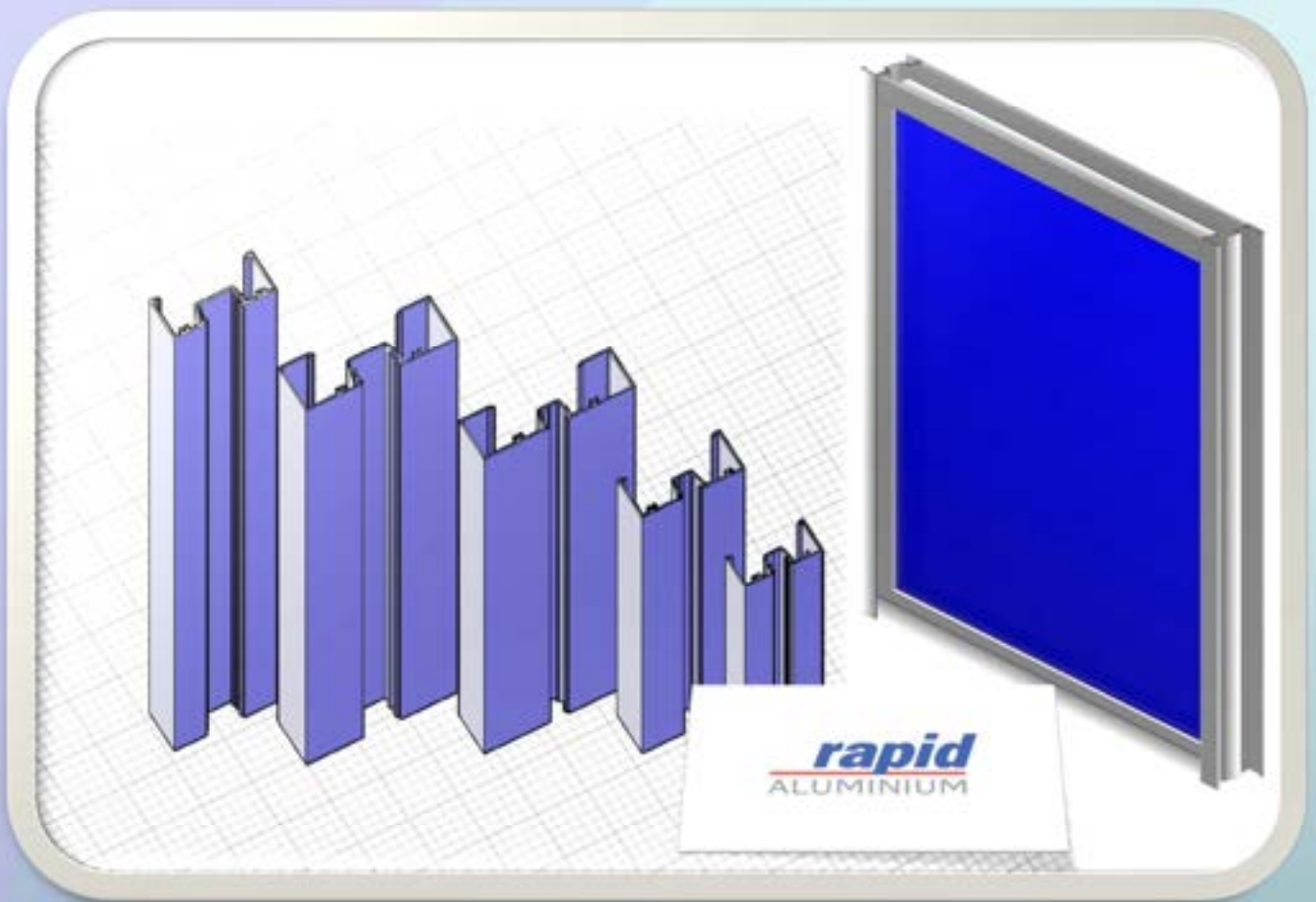

CENTRE GLAZE COMMERCIAL SYSTEMS

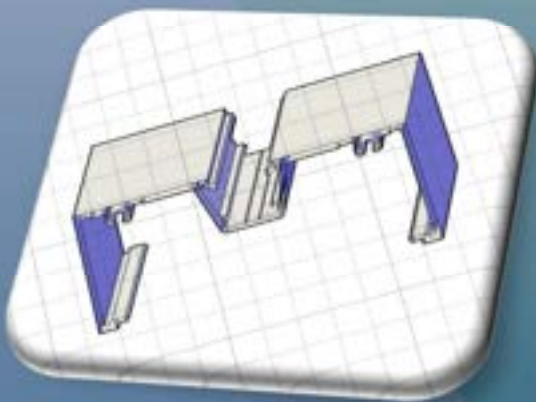

The most widely used commercial framing system, which allows for versatility and and is ideal for most commercial and residential applications.

400 SERIES CENTRE GLAZE (101.6mm FRAME)

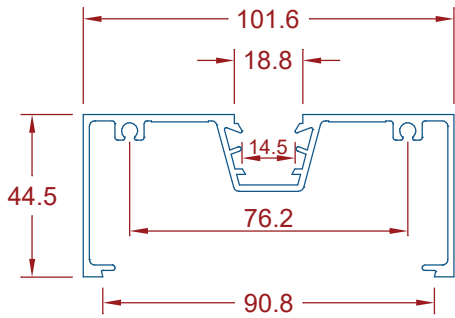

BW400 - Standard Frame

(Accepts: BW404, CF405, CF406, CF407, CF432, BW444, CF451)
(Glazing wedges refer page 16)

Length	Offered Finishes
6.5mtr	Mill / Natural Anodised / Powdercoated

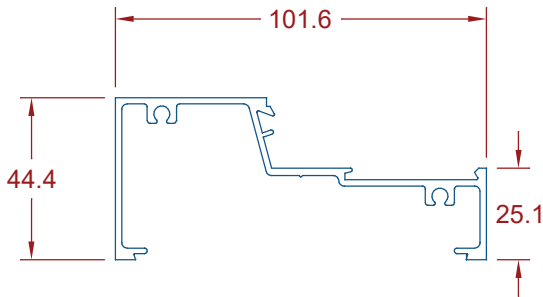

BW402 - Standard Sill

(Accepts: CF403, CF405, CF406, BW404, BW444)
(Glazing wedges refer page 16)

Length	Offered Finishes
6.5mtr	Mill / Natural Anodised / Powdercoated

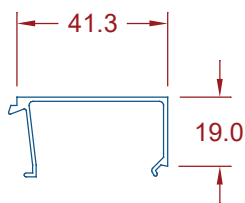

CF403 - Sill Bead

(Accepts: BW402, CF472)

Length	Offered Finishes
6.5mtr	Mill / Natural Anodised / Powdercoated

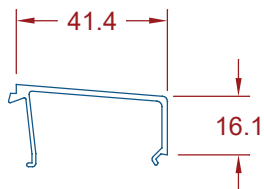

CF403B - Sloping Sill Bead

(Accepts: BW402 & CF434)

Length	Offered Finishes
6.5mtr	Mill / Natural Anodised / Powdercoated

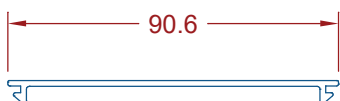

CF405 - Flat Filler

(Accepts: BW400, CF400B, BW401, BW402, BW418, CF436, CF8131, CF701, CF702, CF751, CF752, CF601, CF101CW, DG101, DG601)

Length	Offered Finishes
6.5mtr	Mill / Natural Anodised / Powdercoated

Please note: Images are not to scale

400 SERIES CENTRE GLAZE (101.6mm FRAME)

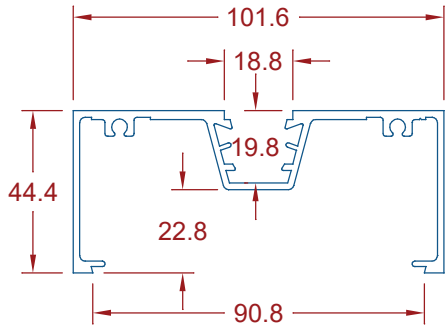

BW401 - Heavy Frame

(Accepts: BW404, CF405, CF406, CF407, CF432, BW444, CF451)
(Glazing wedges refer page 16)

Length	Offered Finishes
6.5mtr	Mill / Natural Anodised / Powdercoated

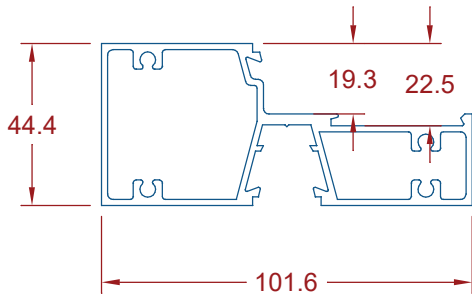

CF472 - Heavy Transom

(Accepts: CF403, CF403B, CF406, CF407)
(Glazing wedges refer page 16)

Length	Offered Finishes
6.5mtr	Mill / Natural Anodised / Powdercoated

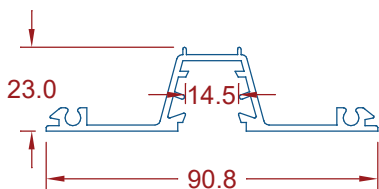

BW444 - HD Glazing Adapter

(Accepts: BW400, BW401, BW402, BW418, CF406, CF407, CF8131)
(Glazing wedges refer page 16)

Length	Offered Finishes
6.5mtr	Mill / Natural Anodised / Powdercoated

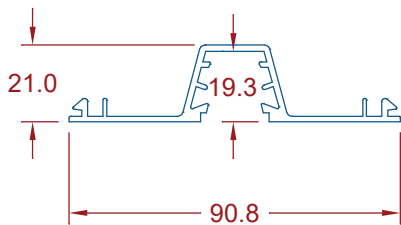

BW404 - Glazing Adapter

(Accepts: BW400, BW401, BW402, BW418, CF406, CF407, CF8131)
(Glazing wedges refer page 16)

Length	Offered Finishes
6.5mtr	Mill / Natural Anodised / Powdercoated

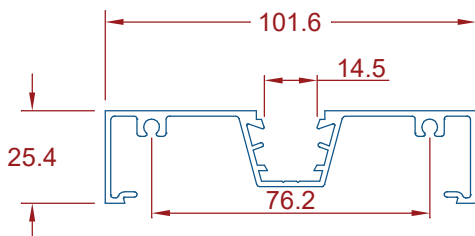

BW436 - Narrow Jamb

(Accepts: CF405, CF406, CF407, CF470)
(Glazing wedges refer page 16)

Length	Offered Finishes
6.5mtr	Mill / Natural Anodised / Powdercoated

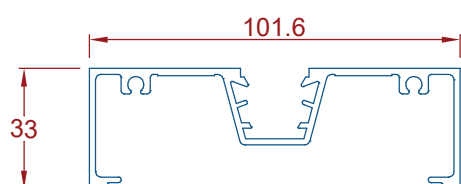

CF450 - 33mm Std Main Frame (101.6 x 33)

(Accepts: CF405, CF406, CF407, CF416, CF432, CF433, CF470)
(Glazing wedges refer page 16)

Length	Offered Finishes
6.5mtr	Mill / Natural Anodised / Powdercoated

Please note: Images are not to scale

400 SERIES CENTRE GLAZE (101.6mm FRAME)

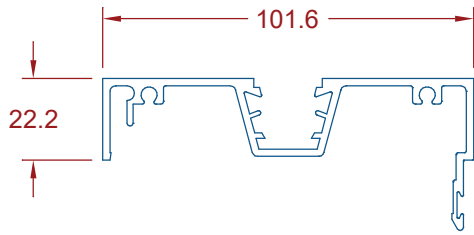

BW427 - Self Mating Mullion

(Accepts: CF406, CF407)

(Accepts : **CFH5** Mullion Seal & wedges page 16)

Length	Offered Finishes
6.5mtr	Mill / Natural Anodised / Powdercoated

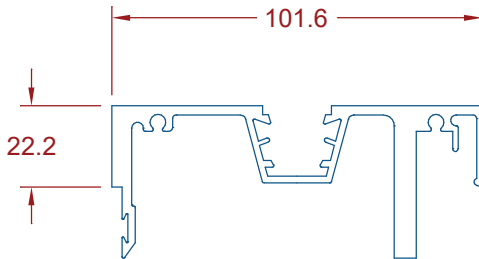

CF428 - HD Mating Mullion

(Accepts: CF406, CF407)

(Accepts : **CFH5** Mullion Seal & wedges page 16)

Length	Offered Finishes
6.5mtr	Mill / Natural Anodised / Powdercoated

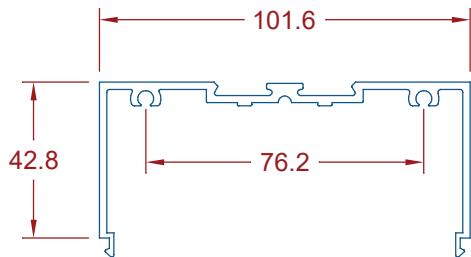

CF423 - COC Closer transom

(Accepts: CF425, CF414 - Ideal for pivot doors)

Length	Offered Finishes
6.5mtr	Mill / Natural Anodised / Powdercoated



CF425 - Flush Filler

(Accepts: CF423)

Length	Offered Finishes
6.5mtr	Mill / Natural Anodised / Powdercoated

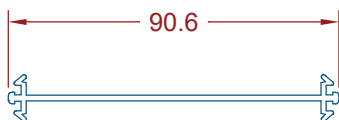

CF470 - Back to Back Adaptor (Coupler Bar)

(Accepts: 101.6mm Frames/Sills)

Length	Offered Finishes
6.5mtr	Mill / Natural Anodised / Powdercoated

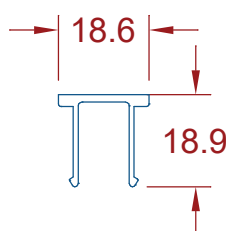

CF406 - Pocket Filler

(Accepts: BW400, BW401, BW404, BW444, BW418, BW436, BW427, CF428, BW601, BW627)

Length	Offered Finishes
6.5mtr	Mill / Natural Anodised / Powdercoated

Please note: Images are not to scale

400 SERIES CENTRE GLAZE (101.6mm FRAME)

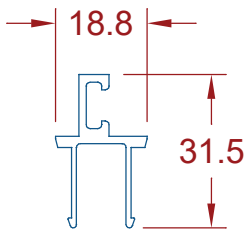

CF407 - 45mm Door Stop

(Accepts: BW400, BW401, BW404, BW444, BW418, BW427, CF428)

(Accepts: **CFH4** & **CFH11**)

Length	Offered Finishes
6.5mtr	Mill / Natural Anodised / Powdercoated

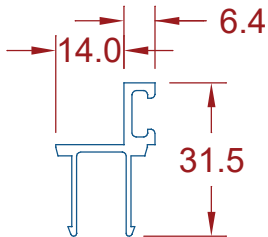

CF432 - 35mm Door Stop

(Accepts: BW400, BW401, BW404, BW444, BW418, BW427, CF428)

(Accepts: **CFH4** & **CFH11**)

Length	Offered Finishes
6.5mtr	Mill / Natural Anodised / Powdercoated

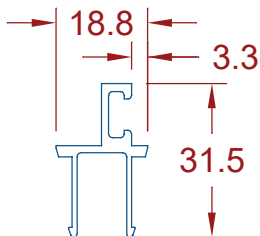

CF433 - 40mm Door Stop

(Accepts: BW400, BW401, BW404, BW444, BW418, BW427, CF428)

(Accepts: **CFH4** & **CFH11**)

Length	Offered Finishes
6.5mtr	Mill / Natural Anodised / Powdercoated

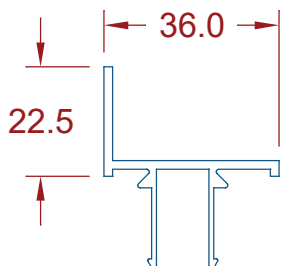

CF416 - 35mm Sash Stop

(Accepts: BW400, BW401, BW404, BW444)

Length	Offered Finishes
6.5mtr	Mill / Natural Anodised / Powdercoated

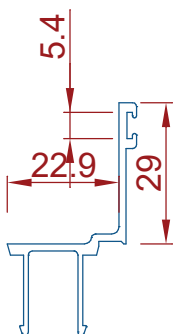

CF7124 - Acoustic Sash Stop

(Accepts: BW400, BW401, BW404, BW444)

(Accepts: **CFH13** & **CFH13D**)

Length	Offered Finishes
6.5mtr	Mill / Natural Anodised / Powdercoated

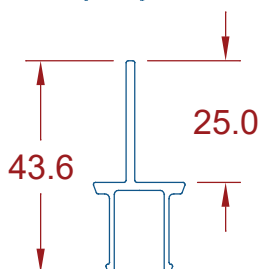

CF4516 - 50mm Sash Stop

(Accepts: BW400, BW401, BW404, BW444)

Length	Offered Finishes
6.5mtr	Mill / Natural Anodised / Powdercoated

Please note: Images are not to scale

400 SERIES CENTRE GLAZE (101.6mm FRAME)

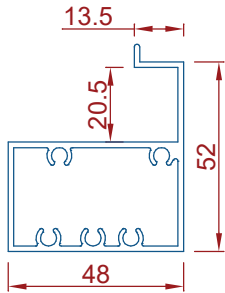

CF467 - Winder Support for 50mm Sash

(Accepts: 50mm Awning Sash)

Length	Offered Finishes
6.5mtr	Mill / Natural Anodised / Powdercoated

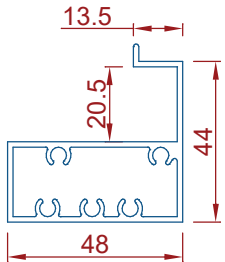

CF466 - Winder Support for 35mm Sash

(Accepts: 35mm Awning Sash)

Length	Offered Finishes
6.5mtr	Mill / Natural Anodised / Powdercoated

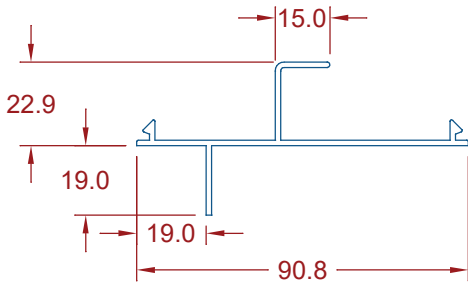

CF451 - Fixing/Reveal Adaptor

(Accepts: 101.6mm Frames)

Length	Offered Finishes
6.5mtr	Mill / Natural Anodised / Powdercoated

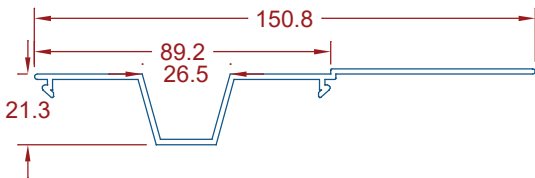

CF471 - Fixing Adaptor

(Accepts: 101.6mm Frames)

Length	Offered Finishes
6.5mtr	Mill / Natural Anodised / Powdercoated

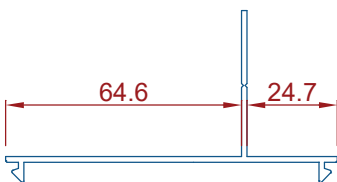

CF484 - Fixing/Reveal Adaptor 30/70

(Accepts: 101.6mm Frames)

Length	Offered Finishes
6.5mtr	Mill / Natural Anodised / Powdercoated

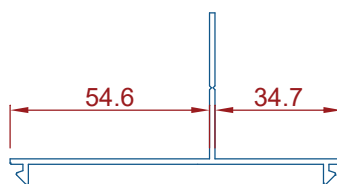

CF485 - Fixing/Reveal Adaptor 40/60

(Accepts: 101.6mm Frames)

Length	Offered Finishes
6.5mtr	Mill / Natural Anodised / Powdercoated

Please note: Images are not to scale

400 SERIES CENTRE GLAZE (101.6mm FRAME)

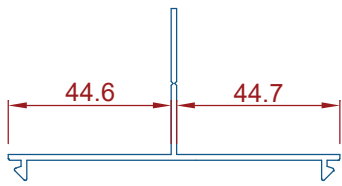

CF486 - Fixing/Reveal Adaptor 50/50

(Accepts: 101.6mm Frames)

Length	Offered Finishes
6.5mtr	Mill / Natural Anodised / Powdercoated

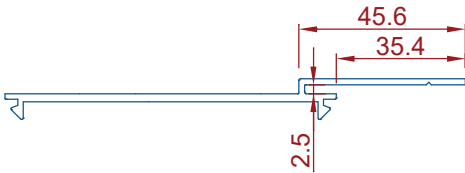

CF473 - Fixing Adaptor (External plaster trim)

(Accepts: 101.6mm Frames)

Length	Offered Finishes
6.5mtr	Mill / Natural Anodised / Powdercoated

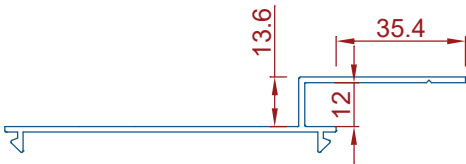

CF488 - Fixing Adaptor (Plaster Return)

(Accepts: 101.6mm Frames)

Length	Offered Finishes
6.5mtr	Mill / Natural Anodised / Powdercoated

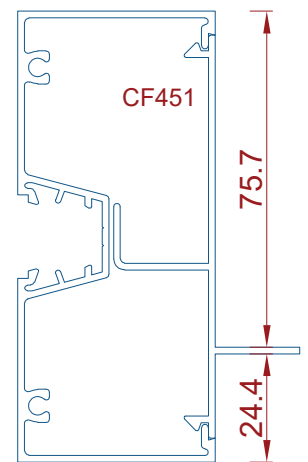
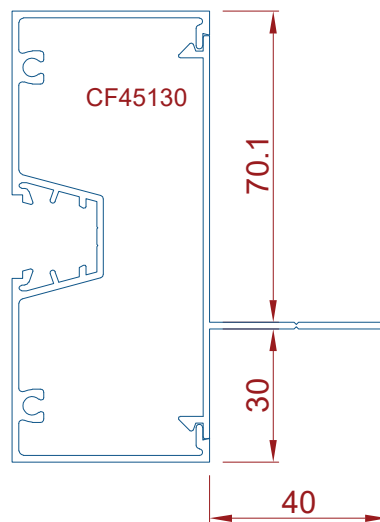
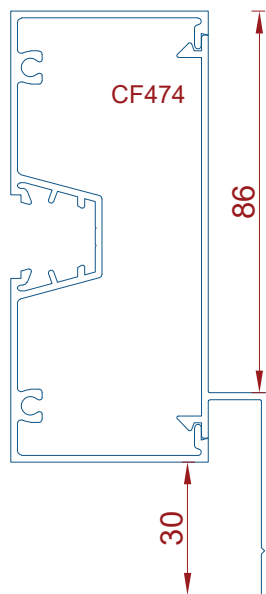
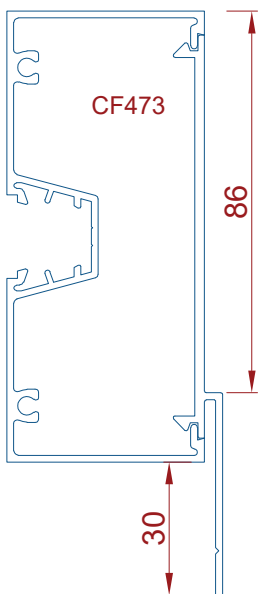

Please note: Images are not to scale

www.rapidal.com.au

400 SERIES CENTRE GLAZE (101.6mm FRAME)

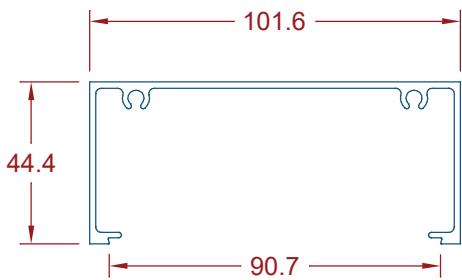

CF8131 - Plain Frame

(Accepts: CF405, BW404, BW444, CF470, CF483, CF704, CF704L)

Length	Offered Finishes
6.5mtr	Mill / Natural Anodised / Powdercoated

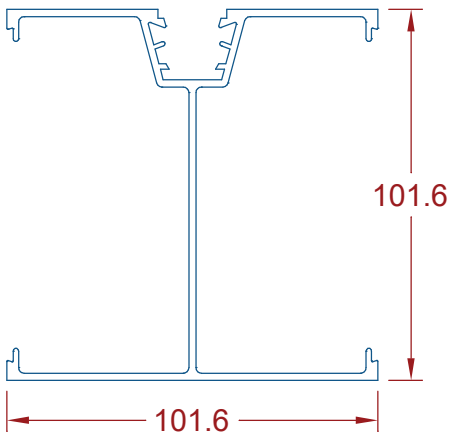

BW418 - Corner Post

(Accepts: CF405, BW404, BW444, CF470, CF483, CF704, CF704L)

(Glazing wedges refer page 16)

Length	Offered Finishes
6.5mtr	Mill / Natural Anodised / Powdercoated

Please note: Images are not to scale

700 SERIES CENTRE GLAZE - DOUBLE GLAZE (101.6mm FRAME)

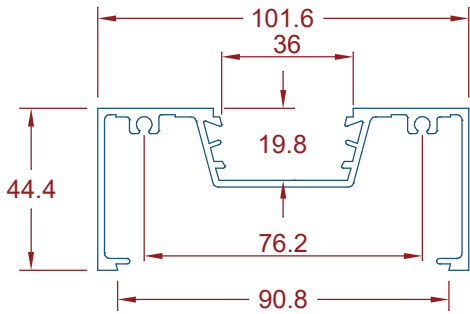

CF701 - DG Standard Frame

(Accepts: BW404, BW444, CF704, CF706, CF716, CF717)

(Glazing wedges refer page 17)

Length	Offered Finishes
6.5mtr	Mill / Natural Anodised / Powdercoated

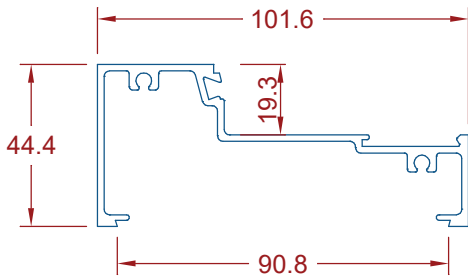

CF702 - DG Sill

(Accepts: BW404, BW444, CF703, CF704)

(Glazing wedges refer page 17)

Length	Offered Finishes
6.5mtr	Mill / Natural Anodised / Powdercoated

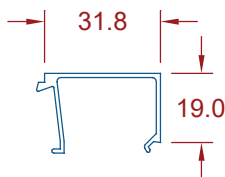

CF703 - DG Sill Bead

(Accepts: CF702)

Length	Offered Finishes
6.5mtr	Mill / Natural Anodised / Powdercoated

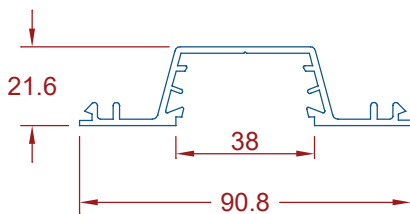

CF704 - DG Glazing Adaptor

(Accepts: CF701, CF706, CF707, CF716, CF717)

(Glazing wedges refer page 17)

Length	Offered Finishes
6.5mtr	Mill / Natural Anodised / Powdercoated

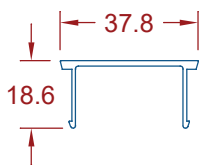

CF706 - DG Pocket Filler

(Accepts: CF701, CF701L, CF704, CF704L, CF727, CF772)

Length	Offered Finishes
6.5mtr	Mill / Natural Anodised / Powdercoated

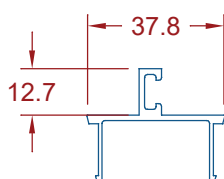

CF707 - DG Door Stop (45mm Door)

(Accepts: CF701, CF701L, CF704, CF704L, CF727, CF772)

(Accepts: **CFH4** & **CFH11**)

Length	Offered Finishes
6.5mtr	Mill / Natural Anodised / Powdercoated

Please note: Images are not to scale

700 SERIES CENTRE GLAZE - DOUBLE GLAZE (101.6mm FRAME)

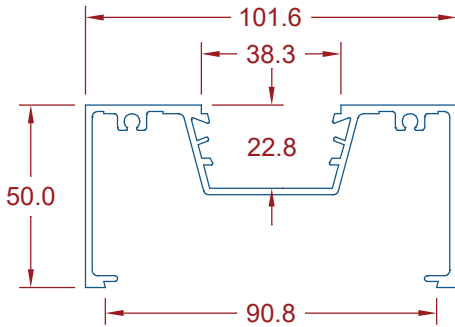

CF701L - DG 50mm Frame

(Accepts: BW404, BW444, CF405, CF704L, CF706, CF707, CF716, CF717)

Length	Offered Finishes
6.5mtr	Mill / Natural Anodised / Powdercoated

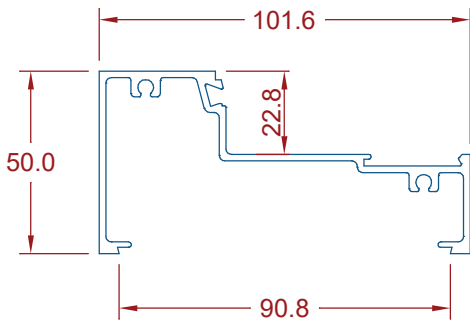

CF702L - DG 50mm Sill

(Accepts: BW404, BW444, CF405, CF703L, CF704L)

Length	Offered Finishes
6.5mtr	Mill / Natural Anodised / Powdercoated

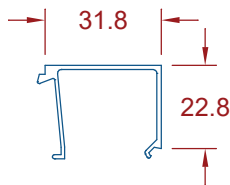

CF703L - DG 50mm Sill Bead

(Accepts: CF702L)

Length	Offered Finishes
6.5mtr	Mill / Natural Anodised / Powdercoated

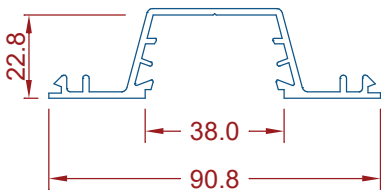

CF704L - DG 50mm Glazing Adaptor

(Accepts: CF701L, CF702L, CF706, CF716, CF717)

Length	Offered Finishes
6.5mtr	Mill / Natural Anodised / Powdercoated

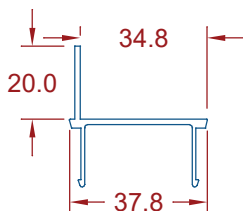

CF716 - DG 35mm Sash Stop

(Accepts: CF701, CF701L, CF704, CF704L)

Length	Offered Finishes
6.5mtr	Mill / Natural Anodised / Powdercoated

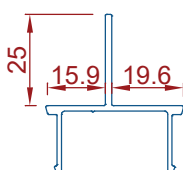

CF717 - DG 50mm Sash Stop

(Accepts: CF701, CF701L, CF704, CF704L)

Length	Offered Finishes
6.5mtr	Mill / Natural Anodised / Powdercoated

Please note: Images are not to scale

700 SERIES CENTRE GLAZE - DOUBLE GLAZE (101.6mm FRAME)

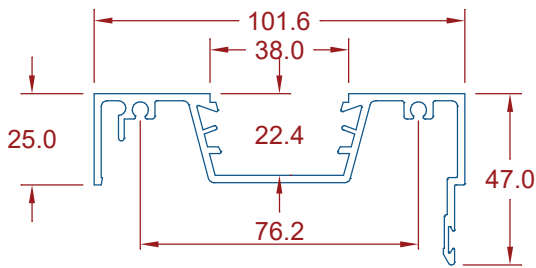

CF727 - DG Self Mating Mullion (50mm)

(Accepts: CF706, CF707, CF716, CF717, CF727)

(Accepts: **CFH5** Mullion Seal)

Length	Offered Finishes
6.5mtr	Mill / Natural Anodised / Powdercoated

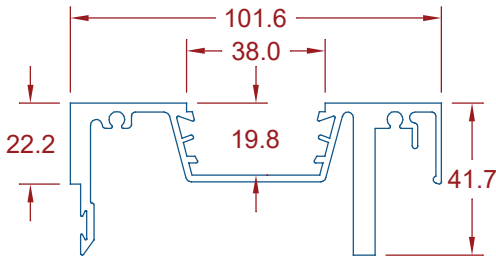

CF728 - DG HD Self Mating Mullion (44.4mm)

(Accepts: CF706, CF707, CF716, CF717, CF728)

(Accepts: **CFH5** Mullion Seal)

Length	Offered Finishes
6.5mtr	Mill / Natural Anodised / Powdercoated

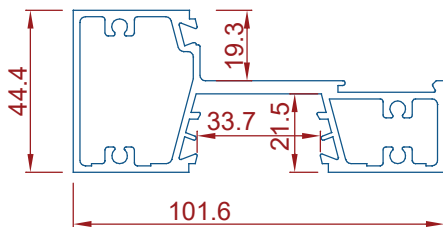

CF772 - DG HD Transom

(Accepts: CF703, CF706, CF716, CF717)

Length	Offered Finishes
6.5mtr	Mill / Natural Anodised / Powdercoated

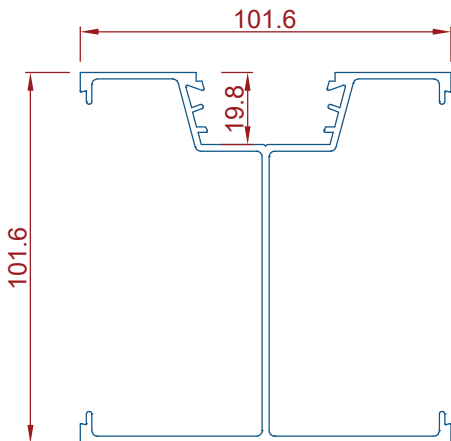

CF718 - DG Corner Post/Coupler

(Accepts: BW404, BW444, CF405, CF704, CF706, CF707)

Length	Offered Finishes
6.5mtr	Mill / Natural Anodised / Powdercoated

Please note: Images are not to scale

750 SERIES CENTRE GLAZE - 50mm DOUBLE GLAZE (101.6mm FRAME)

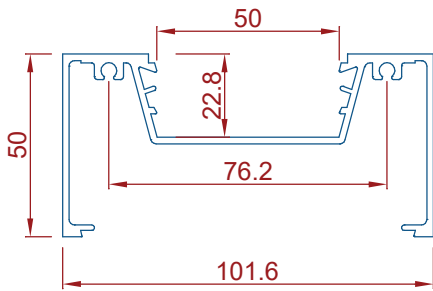

CF751 - DG 50mm Pocket Frame

(Accepts: CF405, CF754)

Length	Offered Finishes
6.5mtr	Mill / Natural Anodised / Powdercoated

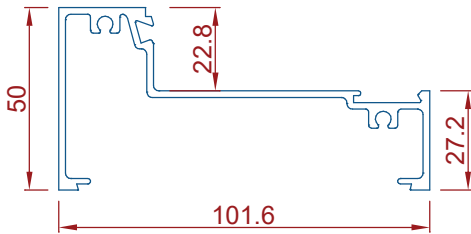

CF752 - DG 50mm Pocket Sill

(Accepts: CF753, CF754)

Length	Offered Finishes
6.5mtr	Mill / Natural Anodised / Powdercoated

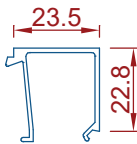

CF753 - DG 50mm Pocket Sill Bead

(Accepts: CF752)

Length	Offered Finishes
6.5mtr	Mill / Natural Anodised / Powdercoated

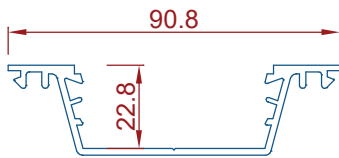

CF754 - DG 50mm Pocket Glazing Adaptor

(Accepts: CF751, CF752)

Length	Offered Finishes
6.5mtr	Mill / Natural Anodised / Powdercoated

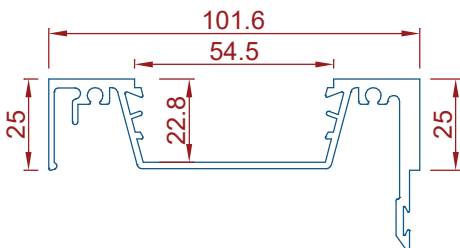

CF7528 - DG 50mm Pocket Self Mating Mullion

(Accepts: CF7528)

(Accepts: **CFH5** Mullion Seal)

Length	Offered Finishes
6.5mtr	Mill / Natural Anodised / Powdercoated

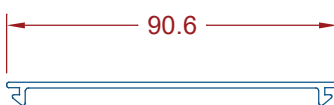

CF405 - Flat Filler

(Accepts: BW400, BW401, BW402, BW418, CF436, CF8131, CF701, CF702, CF751, CF752, BW601, CF101CW, DG101, DG601)

Length	Offered Finishes
6.5mtr	Mill / Natural Anodised / Powdercoated

Please note: Images are not to scale

750 SERIES CENTRE GLAZE - 50mm DOUBLE GLAZE (101.6mm FRAME)

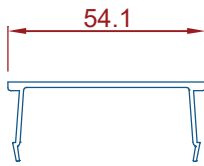

CF756 - DG 50mm Pocket Filler

(Accepts: CF751, CF754 & CF7528)

Length	Offered Finishes
6.5mtr	Mill / Natural Anodised / Powdercoated

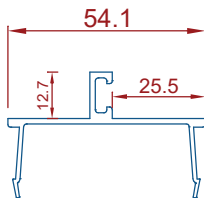

CF757 - DG 50mm Pocket 45mm Door Stop

(Accepts: CF751, CF754 & CF7528)

Length	Offered Finishes
6.5mtr	Mill / Natural Anodised / Powdercoated

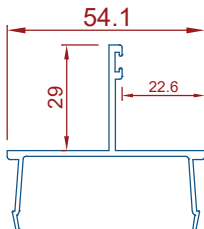

CF758 - DG 50mm Pocket Sash Stop (50mm)

(Accepts: CF751, CF754 & CF7528)

Length	Offered Finishes
6.5mtr	Mill / Natural Anodised / Powdercoated

Please note: Images are not to scale

400/700 SERIES CENTRE GLAZE SUBFRAME (101.6mm FRAME)

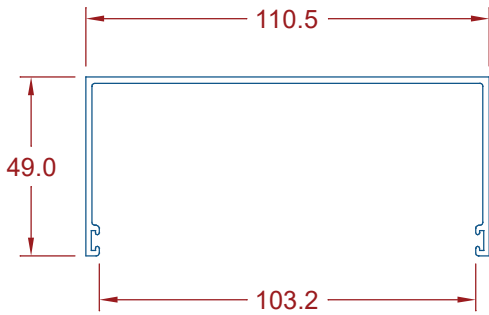

SUBHEAD OPTIONS

CF437 - Standard Subhead (110mm x 49mm)

(Accepts: **CFH13** & **CFH13D**)

Length	Offered Finishes
6.5mtr	Mill / Natural Anodised / Powdercoated

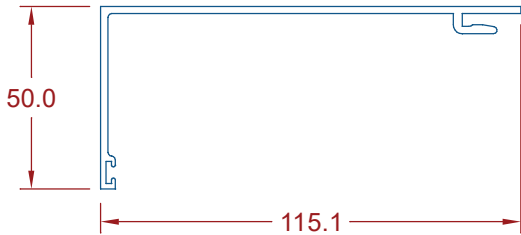

CF458 - 2 Piece Subhead (115mm x 50mm)

(Accepts: CF457)

(Accepts: **CFH13** & **CFH13D**)

Length	Offered Finishes
6.5mtr	Mill / Natural Anodised / Powdercoated

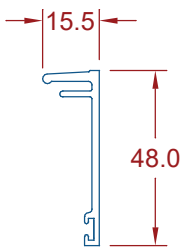

CF457 - 2 Piece Subhead Cover (Pressure Bead)

(Accepts: CF458, CF658)

(Accepts: **CFH13** & **CFH13D**)

Length	Offered Finishes
6.5mtr	Mill / Natural Anodised / Powdercoated

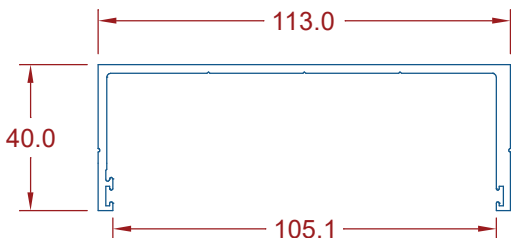

CF477 - HD Subhead (113mm x 40mm)

(Accepts: 101.6mm Frames)

(Accepts: **CFH13** & **CFH13D**)

Length	Offered Finishes
6.5mtr	Mill / Natural Anodised / Powdercoated

Please note: Images are not to scale

400/700 SERIES CENTRE GLAZE SUBFRAME (101.6mm FRAME)

SUBSILL OPTIONS

CF430 - 113mm Slotted Subsill (5.2mm)

(Accepts: 101.6mm Frame & 100mm Thresholds, **CFH13**, **CFH13D**)

Length	Offered Finishes
6.5mtr	Mill / Natural Anodised / Powdercoated

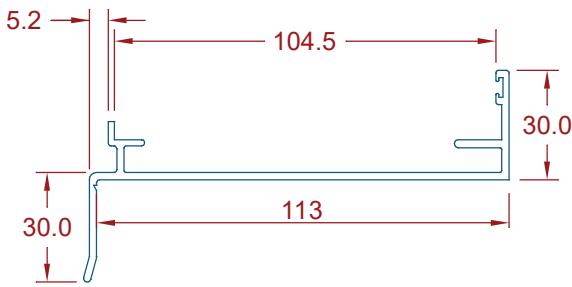

CF420 - 120mm Slotted Subsill (12mm)

(Accepts: 101.6mm Frame & 100mm Thresholds, **CFH13**, **CFH13D**)

Length	Offered Finishes
6.5mtr	Mill / Natural Anodised / Powdercoated

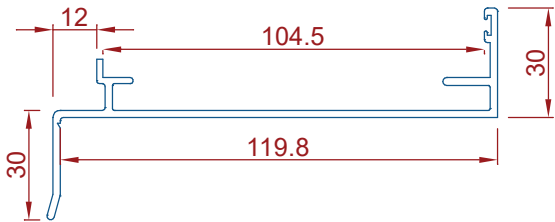

CF420HD - 120mm HD Slotted Subsill (12mm)

(Accepts: 101.6mm Frame & 100mm Thresholds, **CFH13**, **CFH13D**)

Length	Offered Finishes
6.5mtr	Mill / Natural Anodised / Powdercoated

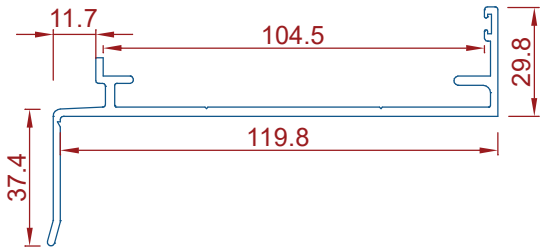

CF431R - 131mm Slotted Subsill (23mm)

(Accepts: 101.6mm Frame & 100mm Thresholds, **CFH13**, **CFH13D**)

Length	Offered Finishes
6.5mtr	Mill / Natural Anodised / Powdercoated

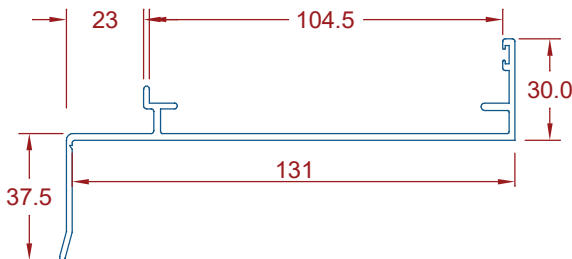

CF462 - 144mm Slotted Subsill (36mm)

(Accepts: 101.6mm Frame & 100mm Thresholds, **CFH13**, **CFH13D**)

Length	Offered Finishes
6.5mtr	Mill / Natural Anodised / Powdercoated

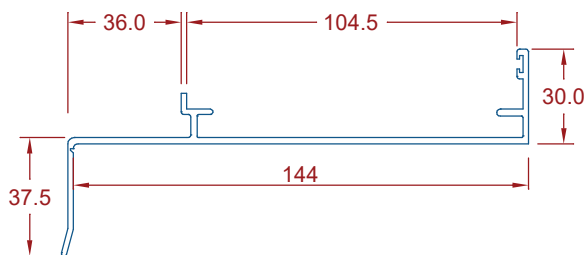

Please note: Images are not to scale

400/700 SERIES CENTRE GLAZE SUBFRAME (101.6mm FRAME)

SUBSILL OPTIONS

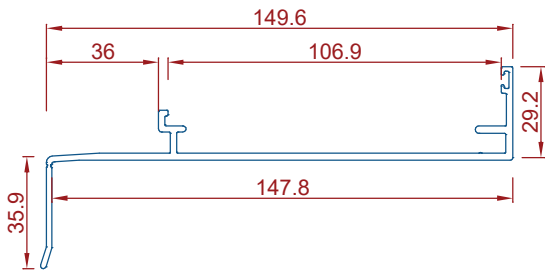

CF462N - 148mm Slotted Subsill (36mm setback)

(Accepts: 101.6mm Frame & 100mm Thresholds, **CFH13**, **CFH13D**)

Length	Offered Finishes
6.5mtr	Mill / Natural Anodised / Powdercoated

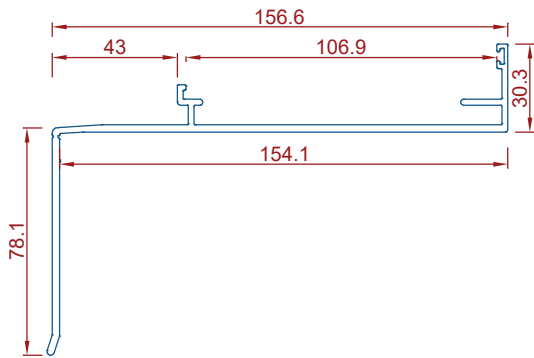

CF463N - 154mm Slotted Subsill (12mm setback)

(Accepts: 101.6mm Frame & 100mm Thresholds, **CFH13**, **CFH13D**)

Length	Offered Finishes
6.5mtr	Mill / Natural Anodised / Powdercoated

Please note: Images are not to scale

400/700 SERIES THRESHOLDS (101.6mm FRAME)

DOOR SILL & THRESHOLD OPTIONS

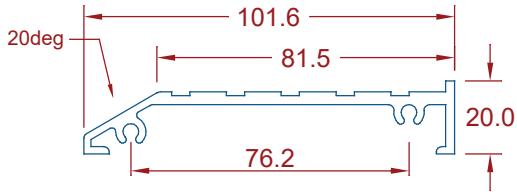

CF438 - Standard Threshold

(Suitable for 101.6mm Frames)

Length	Offered Finishes
6.5mtr	Mill / Natural Anodised / Powdercoated

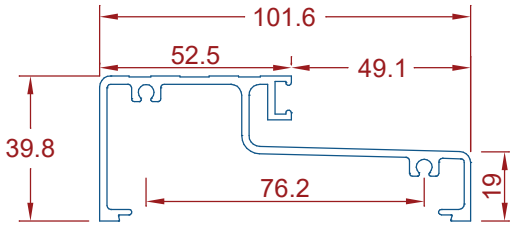

CF439 - Open Out Threshold

(Accepts: CFH4, CF405 & Suitable for 101.6mm Frames)

Length	Offered Finishes
6.5mtr	Mill / Natural Anodised / Powdercoated

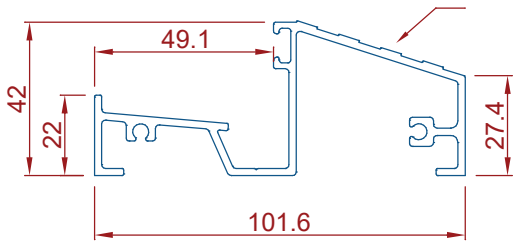

CF489 - Open In Threshold

(Accepts: CFH4 & Suitable for 101.6mm Frames)

Length	Offered Finishes
6.5mtr	Mill / Natural Anodised / Powdercoated

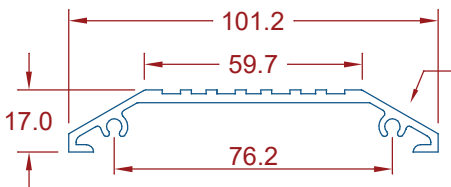

CF468 - Disabled Threshold

(Suitable for 101.6mm Frames)

Length	Offered Finishes
6.5mtr	Mill / Natural Anodised / Powdercoated

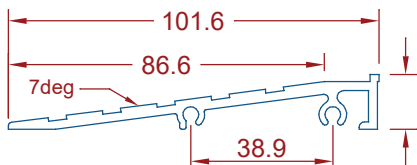

CF469 - Incline Wheelchair Threshold

(Suitable 101.6mm Frames)

Length	Offered Finishes
6.5mtr	anodised / Powdercoated

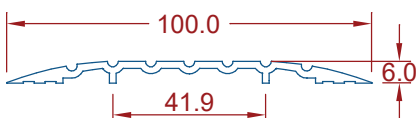





CF478 - Low Profile Threshold

(Suitable for 101.6mm Frames)

Length	Offered Finishes
4.0mtr	anodised / Powdercoated

Please note: Images are not to scale

400 SERIES GLAZING DETAIL

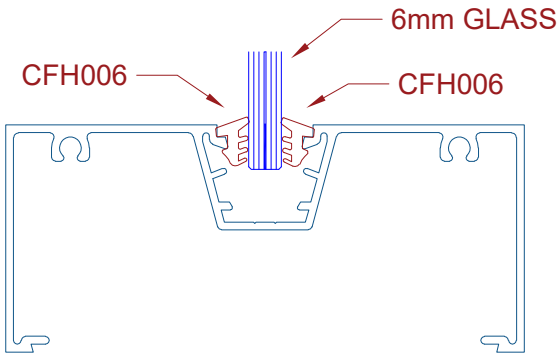
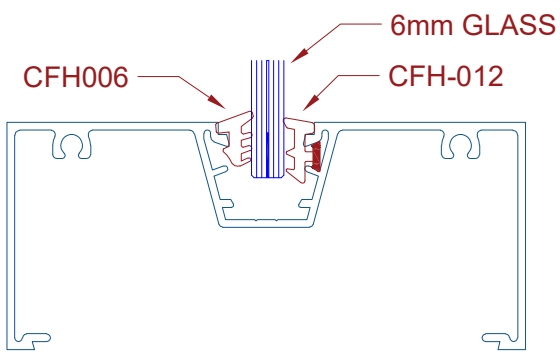
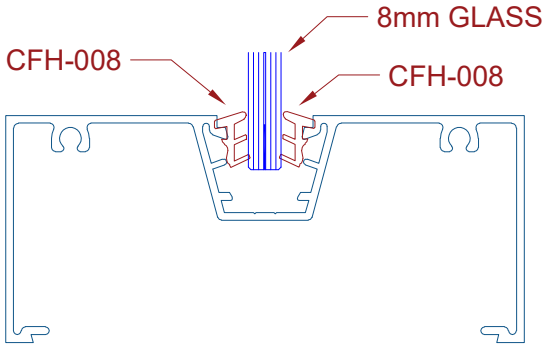
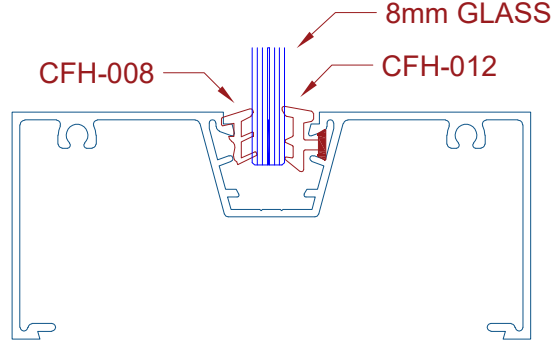
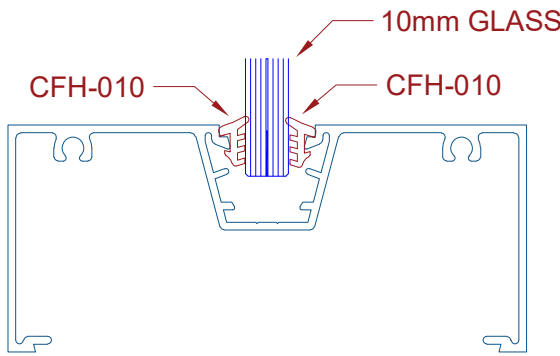
 CFH-006	 CFH-008	 CFH-010	 CO-EX CAPTIVE CFH-012 (WHITE)
FLEXIBLE CAPTIVE WEDGE			
 <p>6mm GLASS CFH006</p>	 <p>6mm GLASS CFH012</p>		
CFH006 = STANDARD PUSH IN WEDGE	CFH-012 = SANTOPRENE CO-EX CAPTIVE WEDGE		
 <p>8mm GLASS CFH-008</p>	 <p>8mm GLASS CFH-012</p>		
CFH006 & CFH008 = STANDARD PUSH IN WEDGE	CFH-008 = PUSH IN WEDGE & CFH-012 = CO-EX		
 <p>10mm GLASS CFH-010</p>			
CFH010 = STANDARD PUSH IN WEDGE			

Please note: Images are not to scale

700 SERIES GLAZING DETAIL (101.6

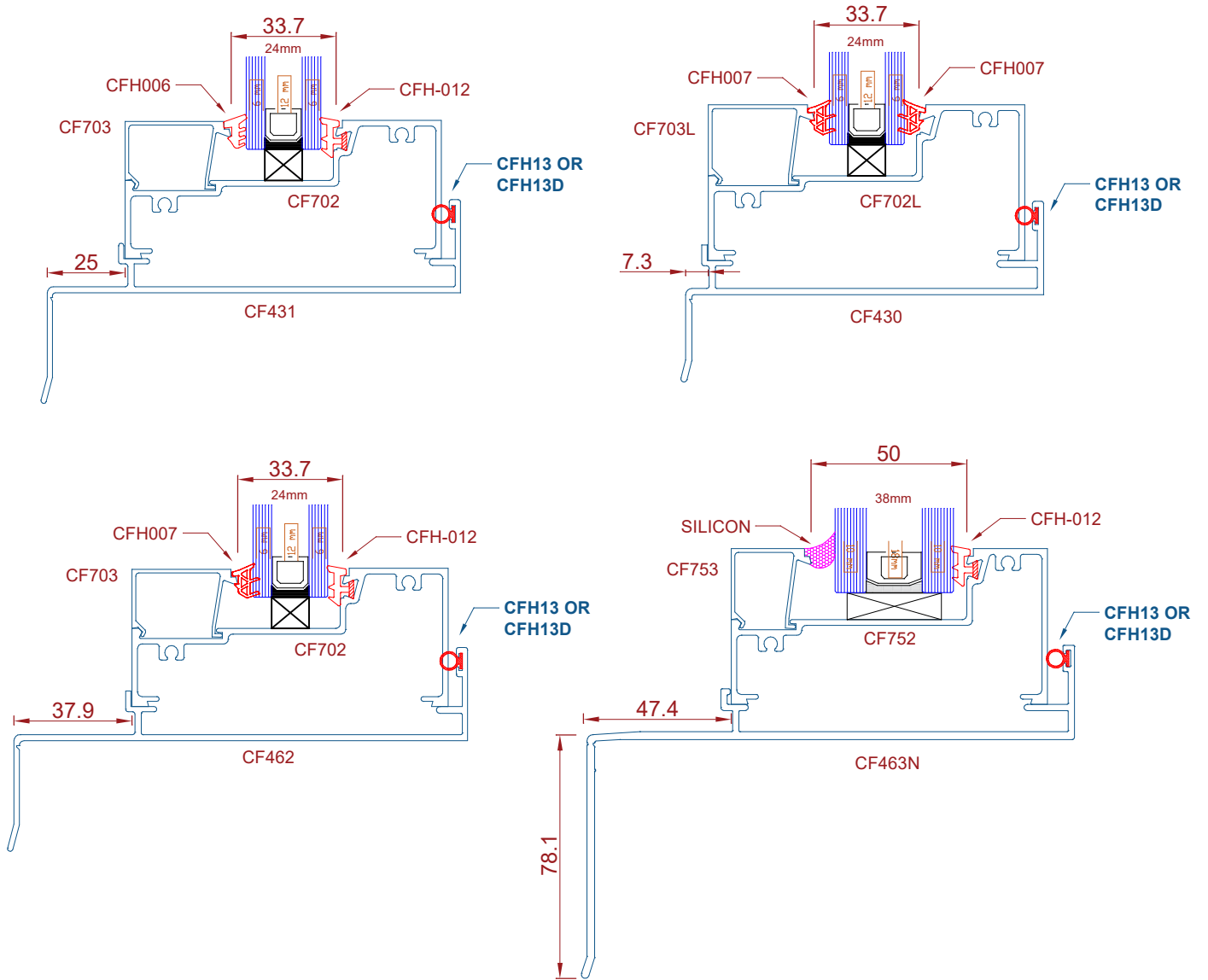

Please note: Images are not to scale

600 SERIES CENTRE GLAZE (150mm FRAME)

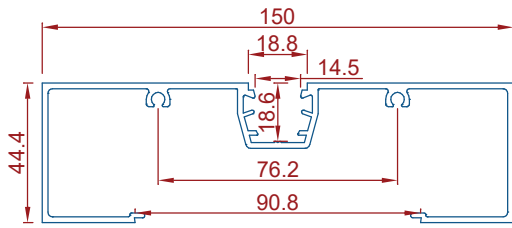

BW601 - SG 150mm Frame

(Accepts: BW404, BW444, CF405, CF406, CF607, CF616, CF704)

Length	Offered Finishes
6.5mtr	Mill / Natural Anodised / Powdercoated

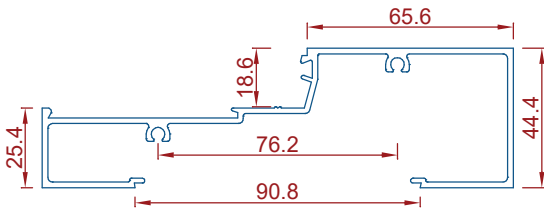

BW602 - SG 150mm Sill

(Accepts: BW404, BW444, CF405, CF704)

Length	Offered Finishes
6.5mtr	Mill / Natural Anodised / Powdercoated

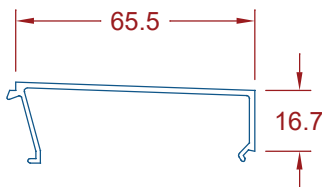

CF603 - 150mm Sill Bead

(Accepts: CF602)

Length	Offered Finishes
6.5mtr	Mill / Natural Anodised / Powdercoated

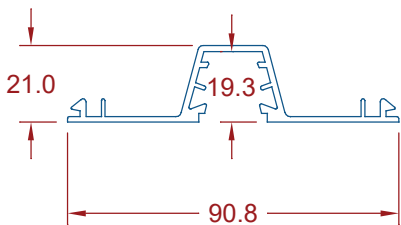

BW404 - Glazing Adapter

(Accepts: BW601, BW602, CF406, CF607, CF616, DG601, DG602)

Length	Offered Finishes
6.5mtr	Mill / Natural Anodised / Powdercoated

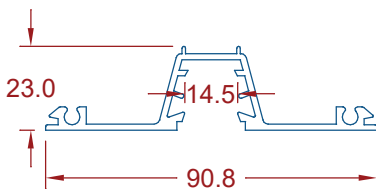

BW444 - HD Adapter

(Accepts: BW601, BW602, CF406, CF607, CF616, DG601, DG602)

Length	Offered Finishes
6.5mtr	Mill / Natural Anodised / Powdercoated

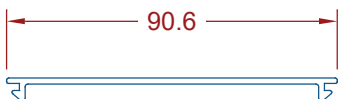

CF405 - Flat Filler

(Accepts: BW601, BW602, DG601, DG602)

Length	Offered Finishes
6.5mtr	Mill / Natural Anodised / Powdercoated

Please note: Images are not to scale

600 SERIES CENTRE GLAZE (150mm FRAME)

CF685 - 150mm Plain Frame

(Accepts: RA265 Flat Filler)

Length	Offered Finishes
6.5mtr	Mill / Natural Anodised / Powdercoated

BW627 - 150mm Self Mating Mullion

(Accepts: CF406, CF607, CF616, CF627)

(Accepts: **CFH5** Mullion Seal)

Length	Offered Finishes
6.5mtr	Mill / Natural Anodised / Powdercoated

CF429 - Plant On Door Stop

(Accepts: **CFH4** & **CFH11**)

Length	Offered Finishes
6.5mtr	Mill / Natural Anodised / Powdercoated

CF429C - Plant On Door Stop With Cover (CF306)

(Accepts: **CFH4** & **CFH11**)

Length	Offered Finishes
6.5mtr	Mill / Natural Anodised / Powdercoated

CF607 - 45mm Door Stop

(Accepts: **CFH4** & **CFH11**)

Length	Offered Finishes
6.5mtr	Mill / Natural Anodised / Powdercoated

CF616 - 35mm Sash Stop

(Accepts: **CFH13** & **CFH13D**)

Length	Offered Finishes
6.5mtr	Mill / Natural Anodised / Powdercoated

CF406 - Pocket Filler

(Accepts: BW601, BW627)

Length	Offered Finishes
6.5mtr	Mill / Natural Anodised / Powdercoated

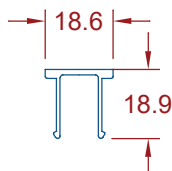
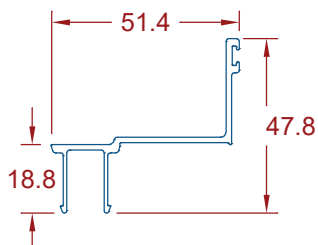
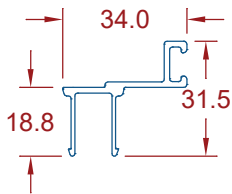
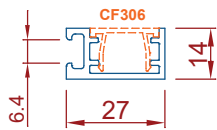
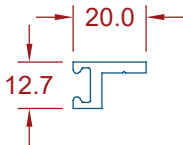
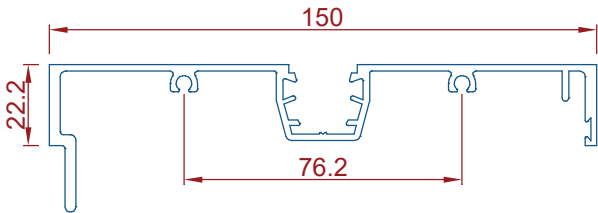
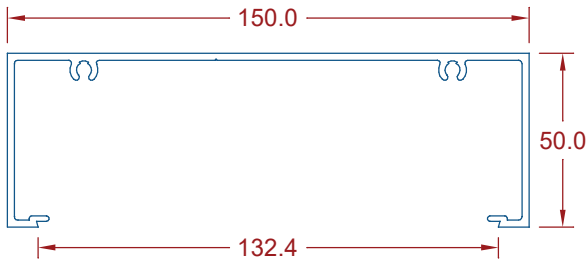

Please note: Images are not to scale

600 SERIES CENTRE GLAZE (150mm FRAME)

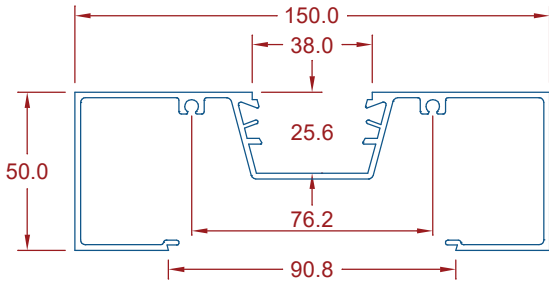

DG601 - 150mm DG Frame

(Accepts: BW404, BW444, CF405, CF704, CF706)

Length	Offered Finishes
6.5mtr	Mill / Natural Anodised / Powdercoated

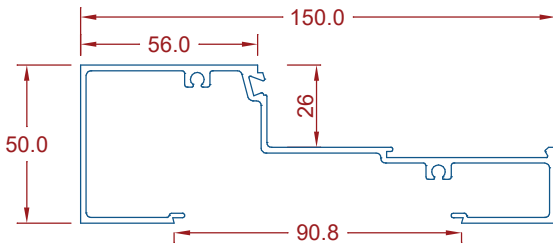

DG602 - 150mm DG Sill

(Accepts: BW404, BW444, CF405, CF704, DG603)

Length	Offered Finishes
6.5mtr	Mill / Natural Anodised / Powdercoated

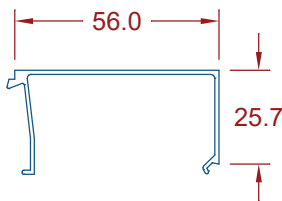

DG603 - 150mm Sill Bead

(Accepts: DG602)

Length	Offered Finishes
6.5mtr	Mill / Natural Anodised / Powdercoated

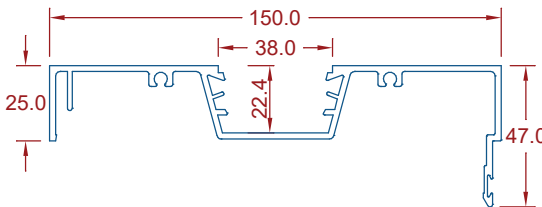

DG627 - 150mm DG Self Mating Mullion

(Accepts: CF704, CF706, DG627)

(Accepts: **CFH5** Mullion Seal)

Length	Offered Finishes
6.5mtr	Mill / Natural Anodised / Powdercoated

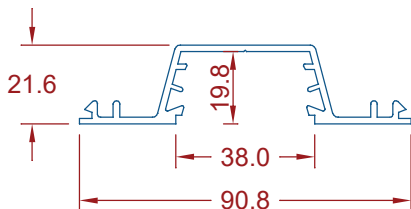

CF704 - DG Glazing Adaptor

(Accepts: CF706, CF707, BW601, BW602, DG601, DG602)

Length	Offered Finishes
6.5mtr	Mill / Natural Anodised / Powdercoated

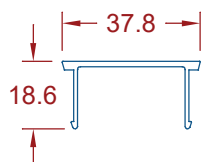

CF706 - DG Pocket Filler

(Accepts: CF701, CF704, DG601, DG627)

Length	Offered Finishes
6.5mtr	Mill / Natural Anodised / Powdercoated

Please note: Images are not to scale

600 SERIES CENTRE GLAZE (150mm FRAME)

SUBHEAD, SUBSILL & THRESHOLD OPTIONS

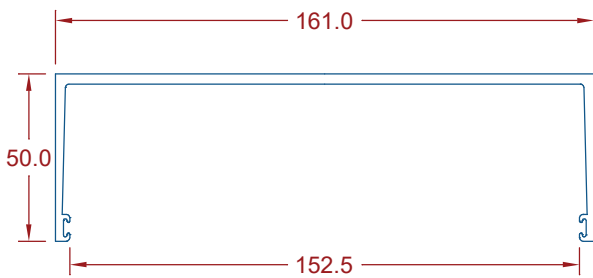

CF637 - 150mm Subhead

(Accepts: **CFH13** & **CFH13D**) Suits 150mm Frame

Length	Offered Finishes
6.5mtr	Mill / Natural Anodised / Powdercoated

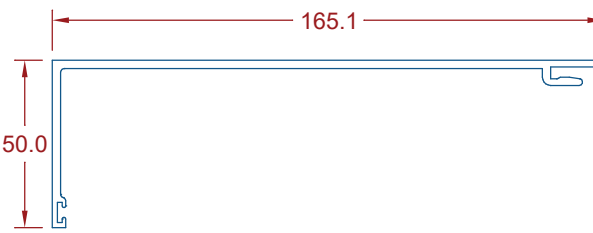

CF658 - 150mm Subhead 2 Piece

(Accepts: CF457) Suits 150mm Frame

(Accepts: **CFH13** & **CFH13D**) Suits 150mm Frame

Length	Offered Finishes
6.5mtr	Mill / Natural Anodised / Powdercoated

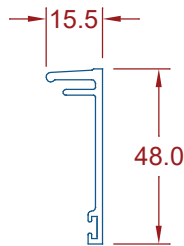

CF457 - 2 Piece Subhead Cover (Pressure Bead)

(Accepts: CF458, CF658)

(Accepts: **CFH13** & **CFH13D**)

Length	Offered Finishes
6.5mtr	Mill / Natural Anodised / Powdercoated

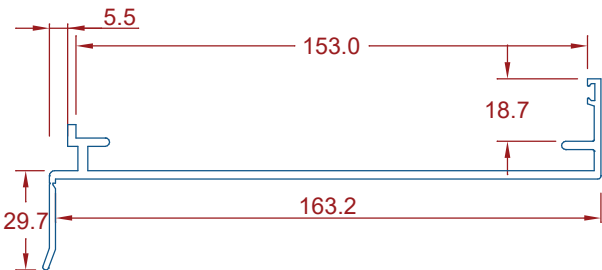

CF630 - 150mm Subsill

(Accepts: **CFH13** & **CFH13D**) Suits 150mm Frame

Length	Offered Finishes
6.5mtr	Mill / Natural Anodised / Powdercoated

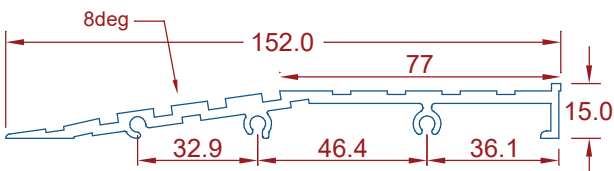

CF669 - 150mm Incline Wheelchair Threshold

Suits 150mm frame & inserts to CF630 Subsill

Length	Offered Finishes
6.5mtr	Mill / Natural Anodised / Powdercoated

Please note: Images are not to scale

600 SERIES GLAZING DETAIL (150mm FRAME)

6mm GLASS

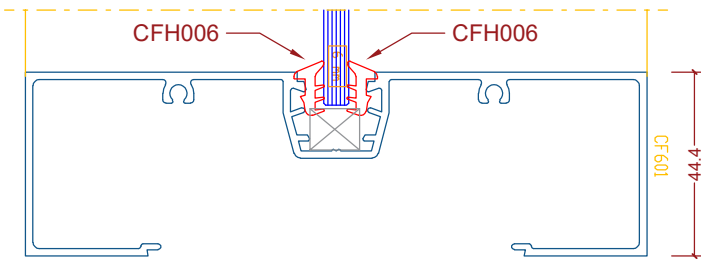

6mm GLASS

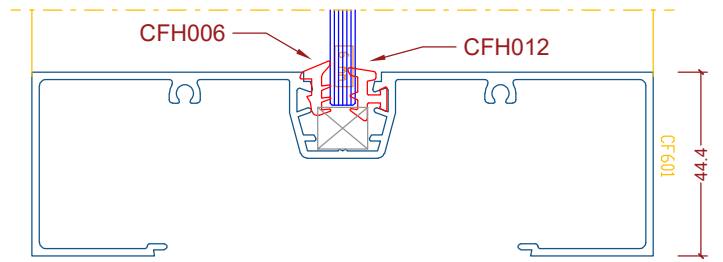

8mm GLASS

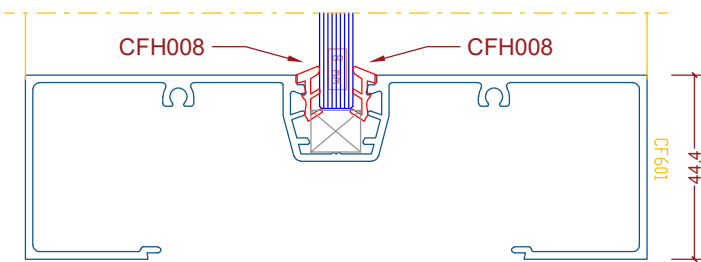

8mm GLASS

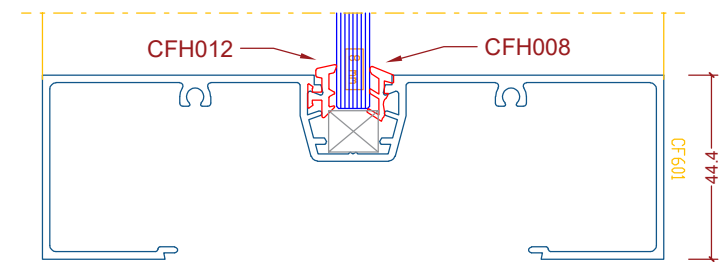

10mm GLASS

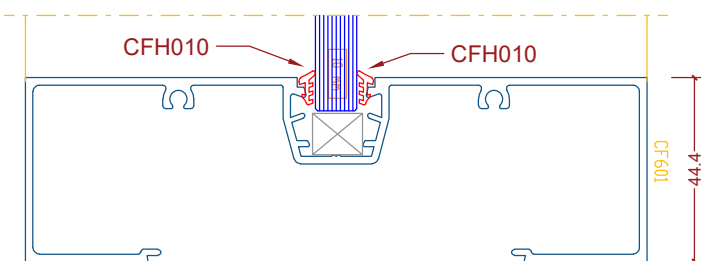

24mm GLASS

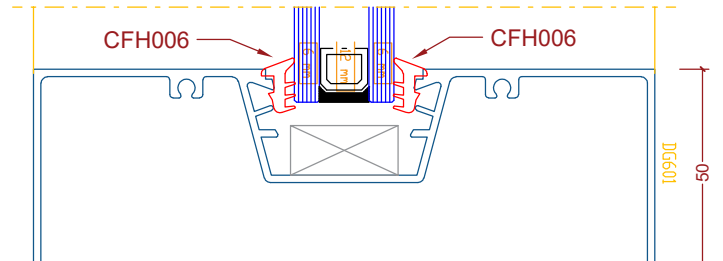

24mm GLASS

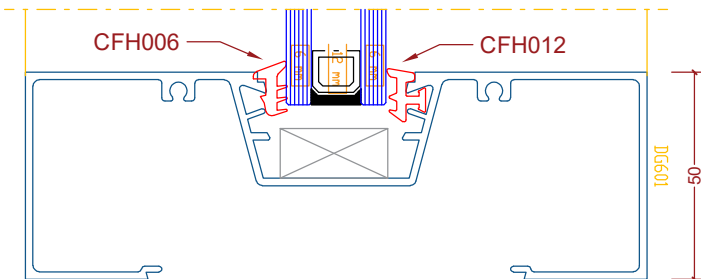

24mm GLASS

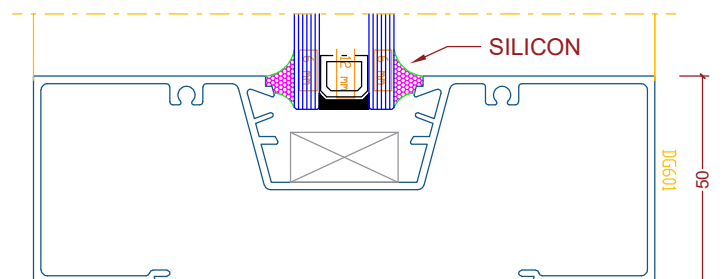

Please note: Images are not to scale

300 SERIES CENTRE GLAZE ARCADE SUITE (76mm x 35mm FRAME)

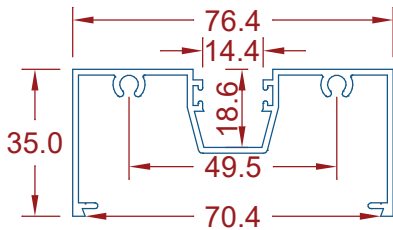

CF301 - 76mm Frame

(Accepts: CF305, CF306, CF307, CF316, CF332)

(Accepts: **CFH014**)

Length	Offered Finishes
6.5mtr	Mill / Natural Anodised / Powdercoated

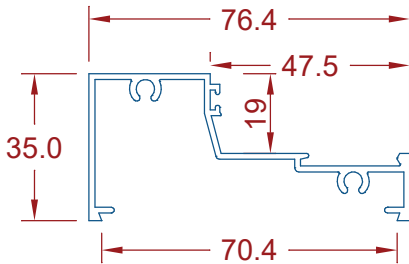

CF302 - 76mm Sill

(Accepts: CF303, CF304)

(Accepts: **CFH014**)

Length	Offered Finishes
6.5mtr	Mill / Natural Anodised / Powdercoated

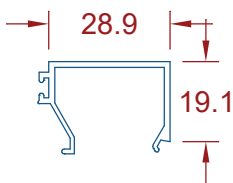

CF303 - 76mm Sill Bead

(Accepts: CF302)

(Accepts: **CFH014**)

Length	Offered Finishes
6.5mtr	Mill / Natural Anodised / Powdercoated

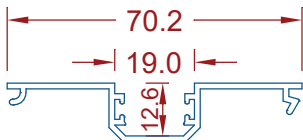

CF304 - Glazing Adapter

(Accepts: CF301, CF302, CF318)

(Accepts: **CFH014**)

Length	Offered Finishes
6.5mtr	Mill / Natural Anodised / Powdercoated

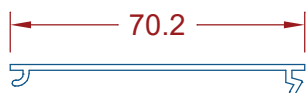

CF305 - Flat Filler

(Accepts: CF301, CF302, CF318)

Length	Offered Finishes
6.5mtr	Mill / Natural Anodised / Powdercoated



CF306 - Pocket Filler

(Accepts: CF301, CF302, CF304, CF318, CF429C)

Length	Offered Finishes
6.5mtr	Mill / Natural Anodised / Powdercoated

Please note: Images are not to scale

300 SERIES CENTRE GLAZE ARCADE SUITE (76mm x 35mm FRAME)

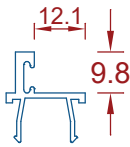

CF332 - 35mm Door Stop

(Accepts: CF301, CF304, CF318)

(Accepts: **CFH4** & **CFH11**)

Length	Offered Finishes
6.5mtr	Mill / Natural Anodised / Powdercoated

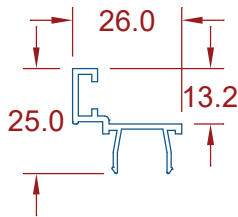

CF307 - 45mm Door Stop

(Accepts: CF301, CF304, CF318)

(Accepts: **CFH4** & **CFH11**)

Length	Offered Finishes
6.5mtr	Mill / Natural Anodised / Powdercoated

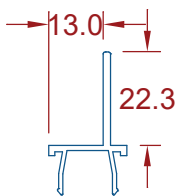

CF316 - 35mm Sash Stop

(Accepts: CF301, CF304, CF318)

Length	Offered Finishes
6.5mtr	Mill / Natural Anodised / Powdercoated

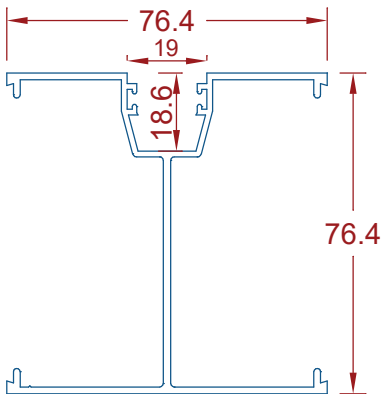

CF318 - 76mm Corner Post

(Accepts: CF304, CF305, CF306, CF307, CF316)

Length	Offered Finishes
6.5mtr	Mill / Natural Anodised / Powdercoated

Please note: Images are not to scale

300 SERIES CENTRE GLAZE ARCADE SUITE (76mm x 35mm FRAME)

SUBHEAD, SUBSILL & FIXING OPTIONS

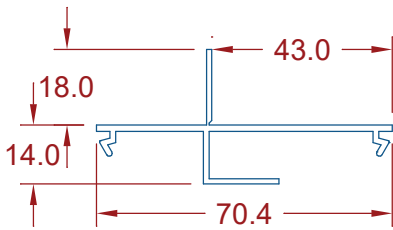

CF351 - Fixing/Reveal Adaptor

(Accepts: CF301, CF302)

Length	Offered Finishes
6.5mtr	Mill / Natural Anodised / Powdercoated

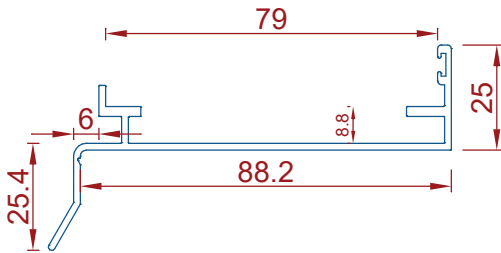

CF330 - Slotted Subsill

(Accepts: 76mm Frames)

Length	Offered Finishes
6.5mtr	Mill / Natural Anodised / Powdercoated

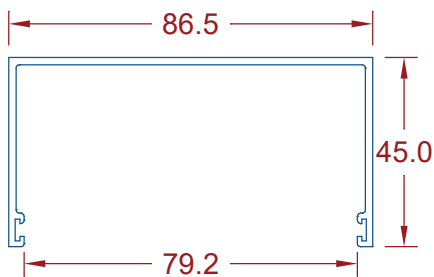

CF337 - Subhead

(Accepts: 76mm Frames)

(Accepts: **CFH24**)

Length	Offered Finishes
6.5mtr	Mill / Natural Anodised / Powdercoated

Please note: Images are not to scale

300 SERIES CENTRE GLAZE ARCADE SUITE (76mm x 35mm FRAME)

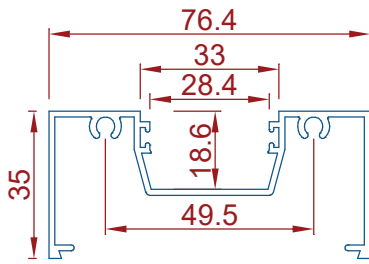

DG311 - DG 76mm Frame

(Accepts: DG314, DG315, DG317, DG318, CF305)

(Accepts: **CFH014**)

Length	Offered Finishes
6.5mtr	Mill / Natural Anodised / Powdercoated

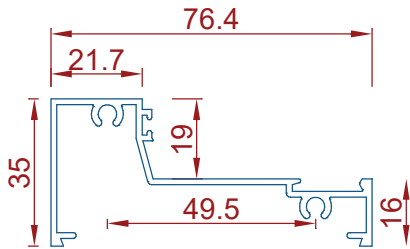

DG312 - DG 76mm Sill

(Accepts: DG313, DG314, CF305)

(Accepts: **CFH014**)

Length	Offered Finishes
6.5mtr	Mill / Natural Anodised / Powdercoated

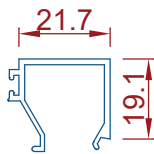

DG313 - DG 76mm Sill Bead

(Accepts: DG302)

(Accepts: **CFH014**)

Length	Offered Finishes
6.5mtr	Mill / Natural Anodised / Powdercoated

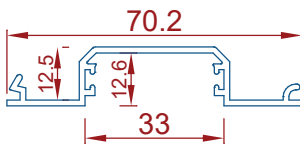

DG314 - DG 76mm Glazing Adaptor

(Accepts: DG311, DG312, DG316, DG317)

(Accepts: **CFH014**)

Length	Offered Finishes
6.5mtr	Mill / Natural Anodised / Powdercoated

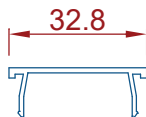

DG315 - DG 76mm Pocket Filler

(Accepts: DG311, DG314)

Length	Offered Finishes
6.5mtr	Mill / Natural Anodised / Powdercoated

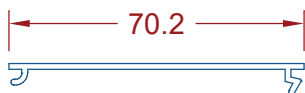

CF305 - 76mm Flat Filler

(Accepts: DG311, DG312, CF301, CF302, CF318)

Length	Offered Finishes
6.5mtr	Mill / Natural Anodised / Powdercoated

Please note: Images are not to scale

300 SERIES CENTRE GLAZE ARCADE SUITE (76mm x 35mm FRAME)

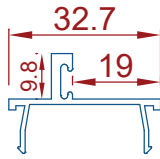

DG316 - 35mm Door Stop

(Accepts: DG311, DG314)

(Accepts: **CFH4** & **CFH11**)

Length	Offered Finishes
6.5mtr	Mill / Natural Anodised / Powdercoated

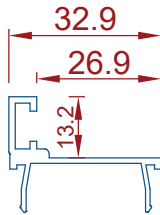

DG317 - 45mm Door Stop

(Accepts: DG311, DG314)

(Accepts: **CFH4** & **CFH11**)

Length	Offered Finishes
6.5mtr	Mill / Natural Anodised / Powdercoated

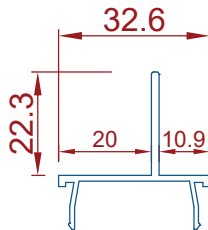

DG318 - 35mm Sash Stop

(Accepts: DG311, DG314)

Length	Offered Finishes
6.5mtr	Mill / Natural Anodised / Powdercoated

Please note: Images are not to scale

300 SERIES ARCADE SUITE GLAZING DETAIL (76mm FRAME)

6mm GLASS

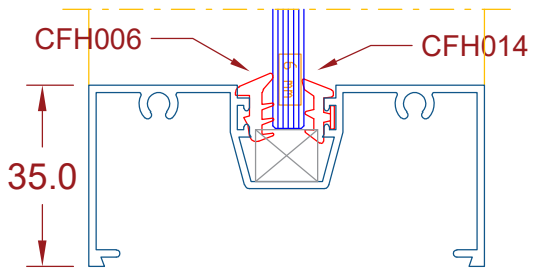

8mm GLASS

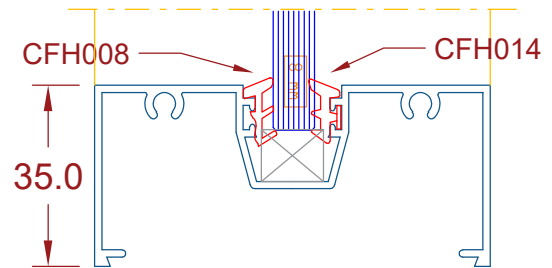

10mm GLASS

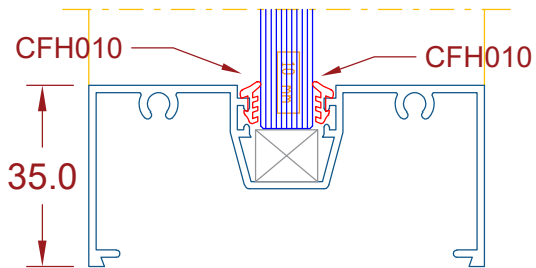

20mm GLASS

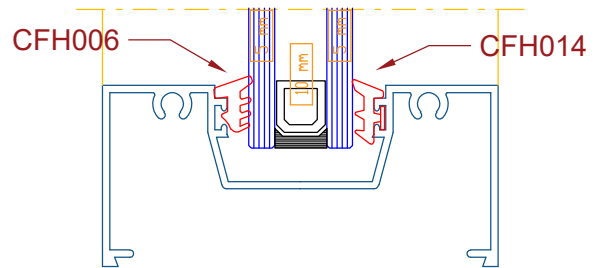

Please note: Images are not to scale

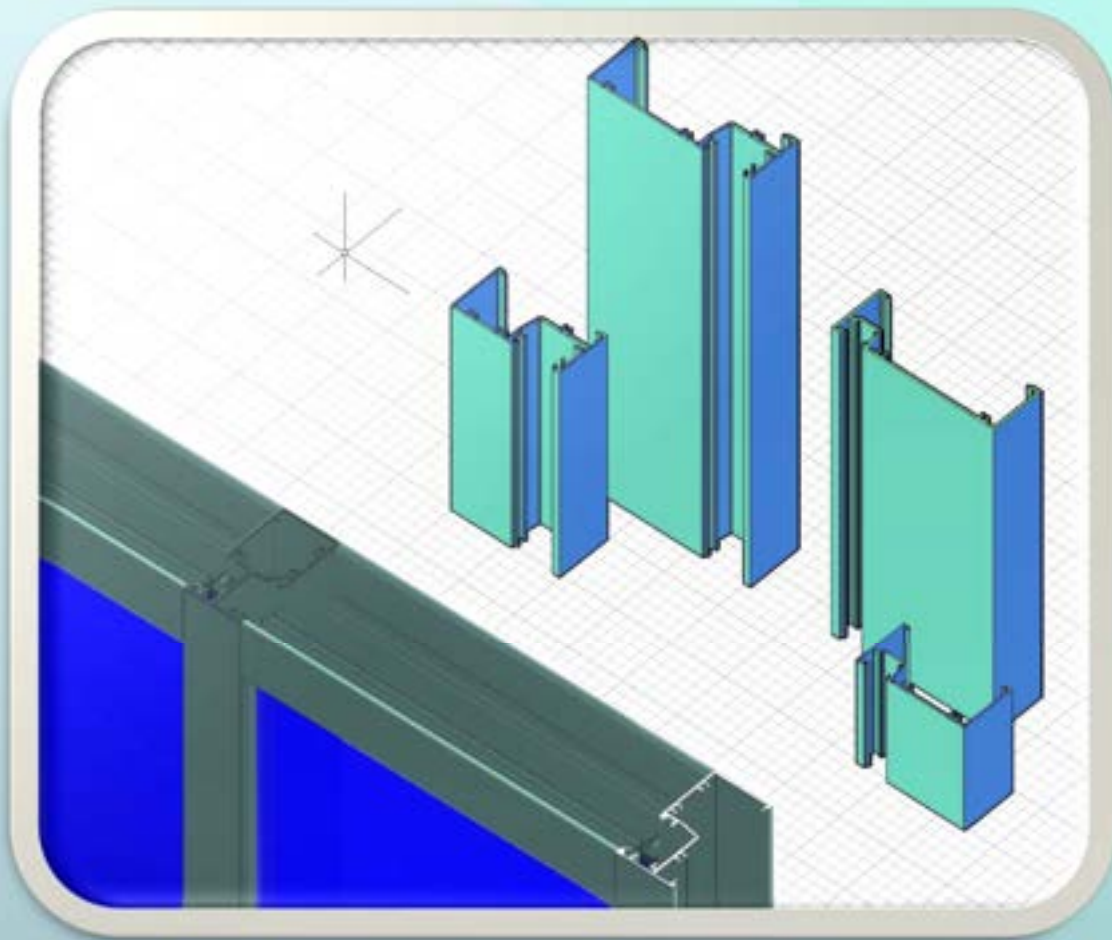

FRONT GLAZE COMMERCIAL SUITE

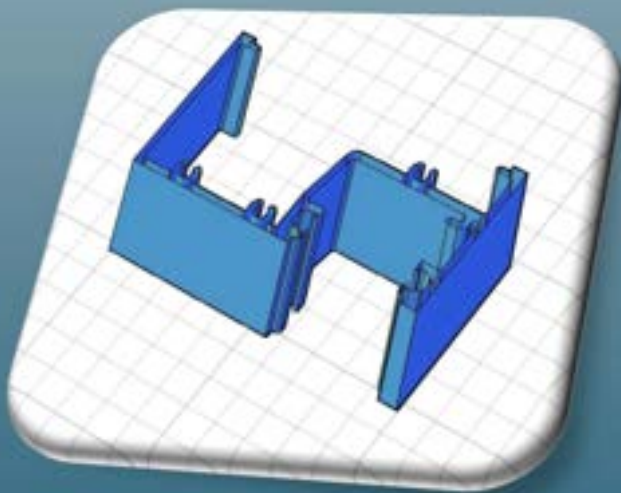

The popular Front Glaze System, unmatched maximum design capabilities intended to give you a modern but clean exterior appearance. Strength and design requirements will be met with both flexibility and uniformity. Available in both single and double glazed including 100mm and 150mm frame depths.

100mm FRONT GLAZE COMMERCIAL SUITE (100mm x 50mm FRAME)

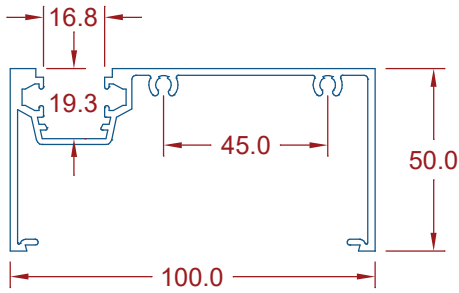

CF101CW - STD Frame

(Accepts: CF106, CF107, CF116, CF156, CF405)

(Accepts: **CFH015**)

Length	Offered Finishes
6.5mtr	Mill / Natural Anodised / Powdercoated

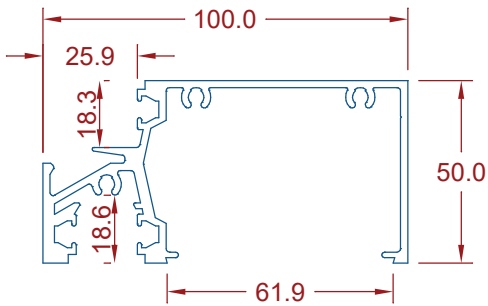

CF102CW - Sill/Transom (External Glazing)

(Accepts: CF104, CF105, CF106, CF107, CF116, CF156)

(Accepts: **CFH015**)

Length	Offered Finishes
6.5mtr	Mill / Natural Anodised / Powdercoated



CF104 - Sill/Transom Bead (External Glazing)

(Accepts: CF102CW, CF115CW)

Length	Offered Finishes
6.5mtr	Mill / Natural Anodised / Powdercoated

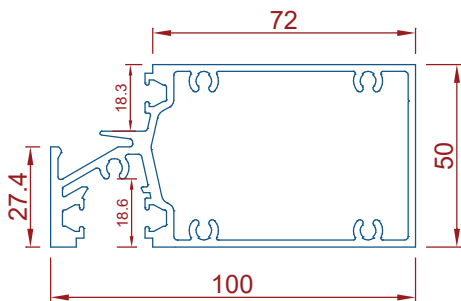

CF115CW - Boxed Sill/Transom (External Glazing)

(Accepts: CF104, CF106, CF107, CF116, CF156)

(Accepts: **CFH015**)

Length	Offered Finishes
6.5mtr	Mill / Natural Anodised / Powdercoated

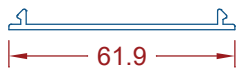

CF105 - Flat Filler

(Accepts: CF102CW, CF114CW)

Length	Offered Finishes
6.5mtr	Mill / Natural Anodised / Powdercoated

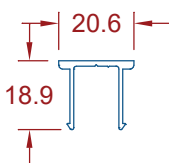

CF106 - Pocket Filler

(Accepts: CF101CW, CF102CW, CF108CW, CF114CW, CF127CW, CF128CW)

Length	Offered Finishes
6.5mtr	Mill / Natural Anodised / Powdercoated

Please note: Images are not to scale

100mm FRONT GLAZE COMMERCIAL SUITE (100mm x 50mm FRAME)

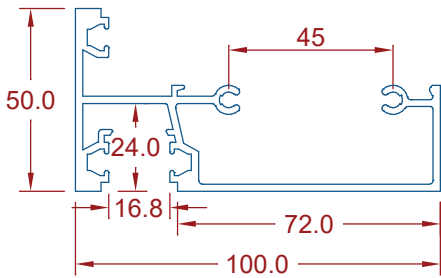

CF108CW - Sill/Transom (Internal Glazing)

(Accepts: CF106, CF109CW)

(Accepts: **CFH015**)

Length	Offered Finishes
6.5mtr	Mill / Natural Anodised / Powdercoated

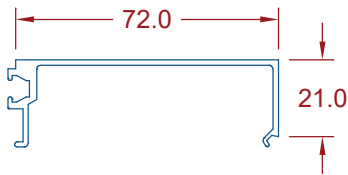

CF109CW - Sill/Transom Bead (Internal Glazing)

(Accepts: CF108CW)

(Accepts: **CFH015**)

Length	Offered Finishes
6.5mtr	Mill / Natural Anodised / Powdercoated

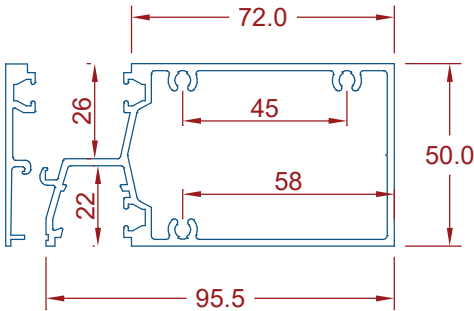

CF110CW - Cover Transom (External Glazing)

(Accepts: CF106, DG117)

(Accepts: **CFH015**)

Length	Offered Finishes
6.5mtr	Mill / Natural Anodised / Powdercoated

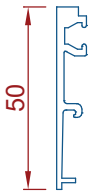

DG117 - Cover Bead (External Glazing)

(Accepts: CF103, CF105, CF106, CF107, CF116, CF156)

(Accepts: **CFH015**)

Length	Offered Finishes
6.5mtr	Mill / Natural Anodised / Powdercoated

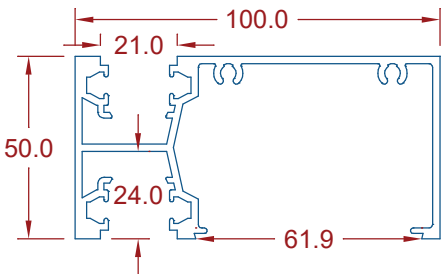

CF114CW - Mullion (Open Box)

(Accepts: CF105, CF106)

(Accepts: **CFH015**)

Length	Offered Finishes
6.5mtr	Mill / Natural Anodised / Powdercoated

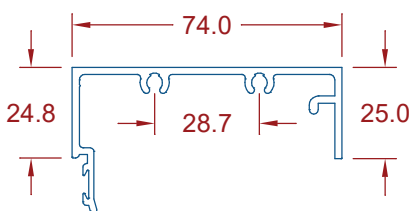

CF113 - Structural Self Mating Mullion

(Accepts: CF113)

(Accepts: **CFH5** Mullion Seal)

Length	Offered Finishes
6.5mtr	Mill / Natural Anodised / Powdercoated

Please note: Images are not to scale

100mm FRONT GLAZE COMMERCIAL SUITE (100mm x 50mm FRAME)

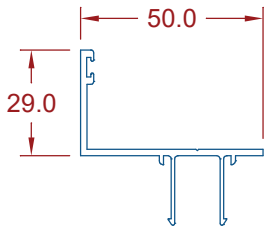

CF156 - 50mm Sash Stop

(Accepts: CF101CW, CF102CW, CF108CW, CF110CW, CF114CW)

(Accepts: **CFH13**)

Length	Offered Finishes
6.5mtr	Mill / Natural Anodised / Powdercoated

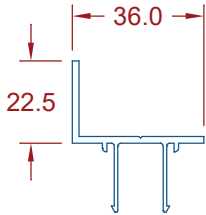

CF116 - 35mm Sash Stop

(Accepts: CF101CW, CF102CW, CF108CW, CF110CW, CF114CW)

Length	Offered Finishes
6.5mtr	Mill / Natural Anodised / Powdercoated

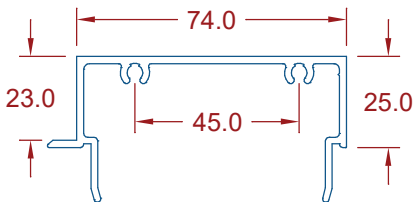

CF125 - Structural Female Split Mullion

(Accepts: CF126)

Length	Offered Finishes
6.5mtr	Mill / Natural Anodised / Powdercoated

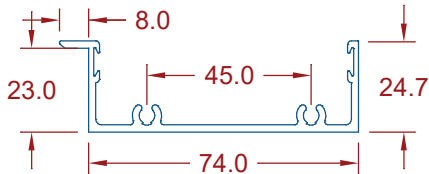

CF126 - Structural Male Split Mullion

(Accepts: CF125)

(Accepts: **CFH5** Mullion Seal)

Length	Offered Finishes
6.5mtr	Mill / Natural Anodised / Powdercoated

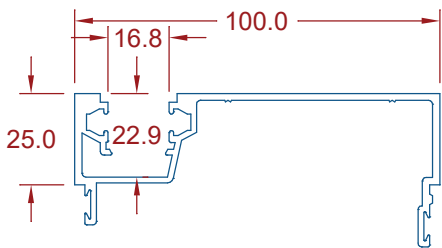

CF128CW - Male Split Mullion

(Accepts: CF127CW, CF117)

(Accepts: **CFH015**, **CFH5** Mullion Seal)

Length	Offered Finishes
6.5mtr	Mill / Natural Anodised / Powdercoated

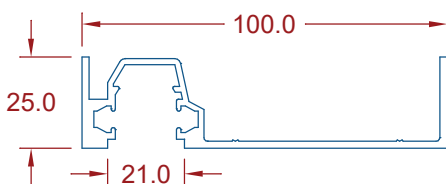

CF127CW - Female Split Mullion

(Accepts: CF128CW, CF117)

(Accepts: **CFH015**)

Length	Offered Finishes
6.5mtr	Mill / Natural Anodised / Powdercoated

Please note: Images are not to scale

100mm FRONT GLAZE COMMERCIAL SUITE (100mm x 50mm FRAME)

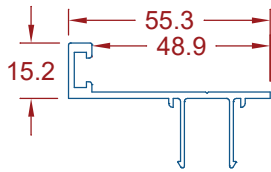

CF107 - 45mm Door Stop

(Accepts: All SG FG glazing pockets)

(Accepts: **CFH4** & **CFH11**)

Length	Offered Finishes
6.5mtr	Mill / Natural Anodised / Powdercoated

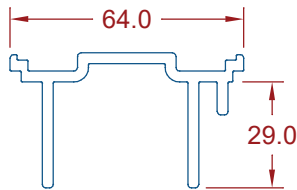

CF117 - 100mm Splice Bar

(Accepts: CF127CW & CF128CW)

Length	Offered Finishes
6.5mtr	Mill / Natural Anodised / Powdercoated

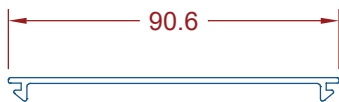

CF405 - Flat Filler

(Accepts: CF101CW)

Length	Offered Finishes
6.5mtr	Mill / Natural Anodised / Powdercoated

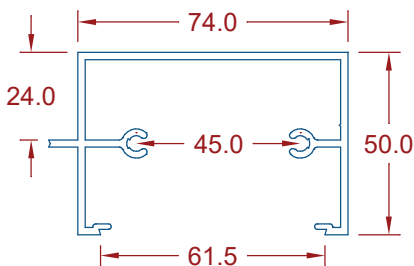

CF112 - Structural Transom

(Accepts: CF105)

Length	Offered Finishes
6.5mtr	Mill / Natural Anodised / Powdercoated

Please note: Images are not to scale

100mm FRONT GLAZE COMMERCIAL SUITE (100mm x 50mm FRAME)

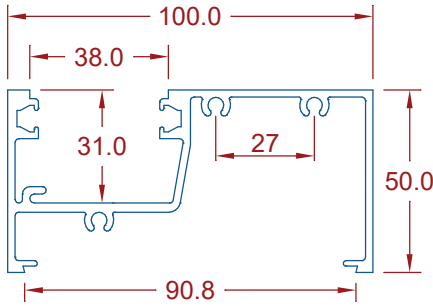

DG101 - DG Frame 100mm x 50mm

(Accepts: CF405, DG106, DG107, DG116, DG156)

(Accepts: **CFH015**)

Length	Offered Finishes
6.5mtr	Mill / Natural Anodised / Powdercoated

DG106 - Pocket Filler

(Accepts: DG101, DG108, DG110, DG114, DG127, DG128, DG122, DG123, DG161, DG162, DG163, DG164, DG167, DG168, DG169, DG171)

Length	Offered Finishes
6.5mtr	Mill / Natural Anodised / Powdercoated

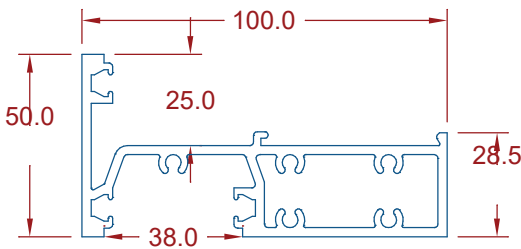

DG108 - DG Internal Transom

(Accepts: DG106, DG107, DG109, DG116, DG156)

(Accepts: **CFH015**)

Length	Offered Finishes
6.5mtr	Mill / Natural Anodised / Powdercoated

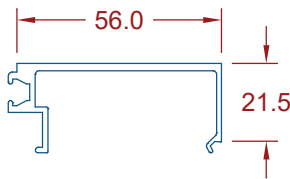

DG109 - DG Internal Transom Bead

(Accepts: DG108)

(Accepts: **CFH015**)

Length	Offered Finishes
6.5mtr	Mill / Natural Anodised / Powdercoated

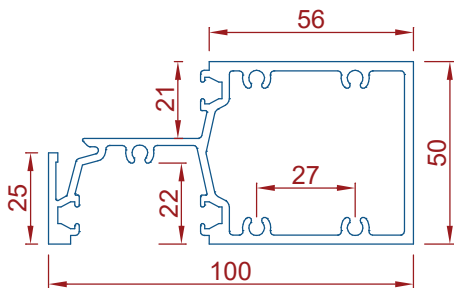

DG112 - DG Boxed Sill/Transom

(Accepts: DG106, DG113, DG116, DG156)

(Accepts: **CFH015**)

Length	Offered Finishes
6.5mtr	Mill / Natural Anodised / Powdercoated

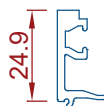

DG113 - DG FG External Bead

(Accepts: DG112, DG172)

(Accepts: **CFH015**)

Length	Offered Finishes
6.5mtr	Mill / Natural Anodised / Powdercoated

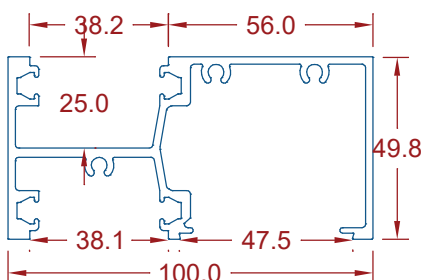

DG114 - DG Head/Jamb Transom

(Accepts: DG105, DG106, DG107, DG116, DG156)

(Accepts: **CFH015**)

Length	Offered Finishes
6.5mtr	Mill / Natural Anodised / Powdercoated

Please note: Images are not to scale

100mm FRONT GLAZE COMMERCIAL SUITE (100mm x 50mm FRAME)

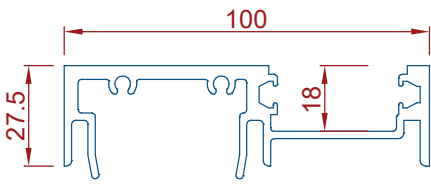

DG127 - DG Female Split Mullion

(Accepts: DG128)

(Accepts: **CFH015** & **CFH5** Mullion Seal)

Length	Offered Finishes
6.5mtr	Mill / Natural Anodised / Powdercoated

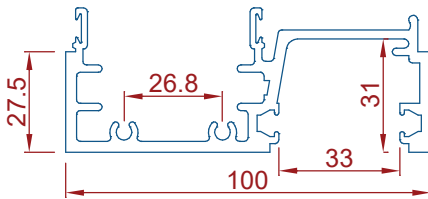

DG128 - DG Male Split Mullion

(Accepts: DG127)

(Accepts: **CFH015** & **CFH5** Mullion Seal)

Length	Offered Finishes
6.5mtr	Mill / Natural Anodised / Powdercoated

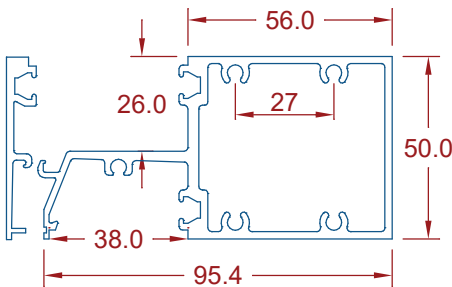

DG110 - DG Cover Transom

(Accepts: DG117, DG106, DG107, DG116, DG156)

(Accepts: **CFH015**)

Length	Offered Finishes
6.5mtr	Mill / Natural Anodised / Powdercoated

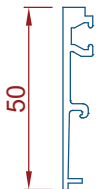

DG117 - Cover Bead

(Accepts: CF110CW, CF171CW, DG110, DG171)

Length	Offered Finishes
6.5mtr	Mill / Natural Anodised / Powdercoated



DG105 - DG Internal Flat Filler

(Accepts: DG114)

Length	Offered Finishes
6.5mtr	Mill / Natural Anodised / Powdercoated

Please note: Images are not to scale

100mm FRONT GLAZE COMMERCIAL SUITE (100mm x 50mm FRAME)

DG116 - DG 35mm Sash Stop

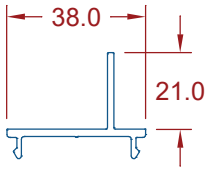

Fits most Front Glazed Double Glazed Pockets

Length	Offered Finishes
6.5mtr	Mill / Natural Anodised / Powdercoated

DG156 - DG 50mm Sash Stop

Fits most Front Glazed Double Glazed Pockets

(Accepts: **CFH13**)

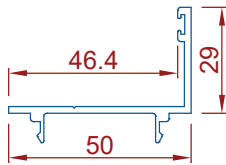

Length	Offered Finishes
6.5mtr	Mill / Natural Anodised / Powdercoated

DG107 - DG 45mm Door Stop

Fits most Front Glazed Double Glazed Pockets

(Accepts: **CFH4** & **CFH11**)

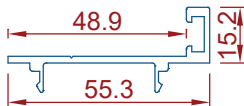

Length	Offered Finishes
6.5mtr	Mill / Natural Anodised / Powdercoated

Please note: Images are not to scale

100mm FRONT GLAZE COMMERCIAL SUITE (100mm x 50mm FRAME)

SUBHEAD OPTIONS

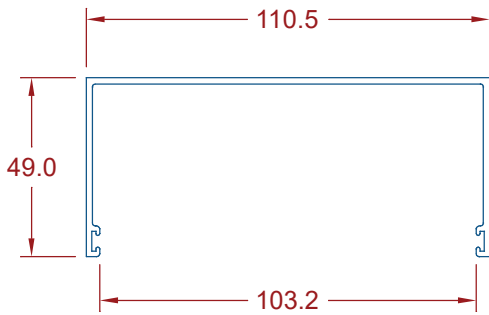

CF437 - Standard Subhead (110mm x 49mm)

(Accepts **CFH13** & **CFH13D**)

Length	Offered Finishes
6.5mtr	Mill / Natural Anodised / Powdercoated

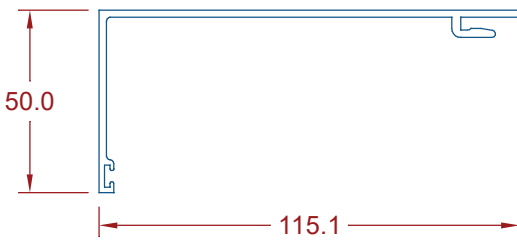

CF458 - 2 Piece Subhead (115mm x 50mm)

(Accepts: CF457)

(Accepts **CFH13** & **CFH13D**)

Length	Offered Finishes
6.5mtr	Mill / Natural Anodised / Powdercoated

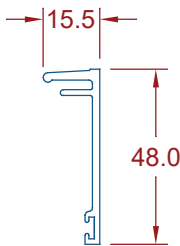

CF457 - 2 Piece Subhead Cover (50mm)

(Accepts: CF458, CF658)

(Accepts **CFH13** & **CFH13D**)

Length	Offered Finishes
6.5mtr	Mill / Natural Anodised / Powdercoated

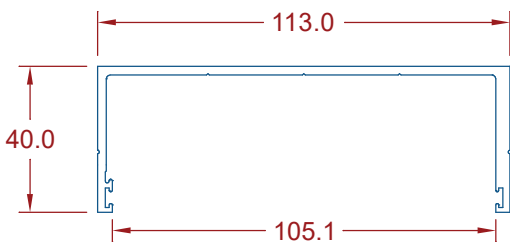

CF477 - Heavy Duty Subhead (113mm x 40mm)

(Accepts **CFH13** & **CFH13D**)

Length	Offered Finishes
6.5mtr	Mill / Natural Anodised / Powdercoated

Please note: Images are not to scale

100mm FRONT GLAZE COMMERCIAL SUITE (100mm x 50mm FRAME)

SUBSILL OPTIONS

CF430 - 113mm Slotted Subsill (5.2mm)

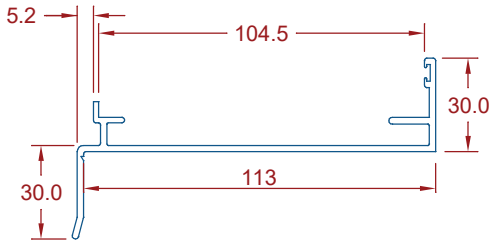

(Accepts: 101.6mm Frame & 100mm Thresholds, **CFH13**, **CFH13D**)

Length	Offered Finishes
6.5mtr	Mill / Natural Anodised / Powdercoated

CF420 - 120mm Slotted Subsill (12mm)

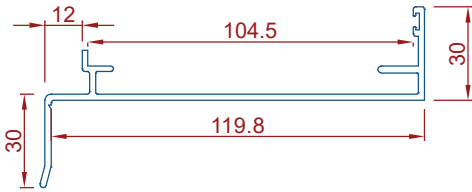

(Accepts: 101.6mm Frame & 100mm Thresholds, **CFH13**, **CFH13D**)

Length	Offered Finishes
6.5mtr	Mill / Natural Anodised / Powdercoated

CF420HD - 120mm HD Slotted Subsill (12mm)

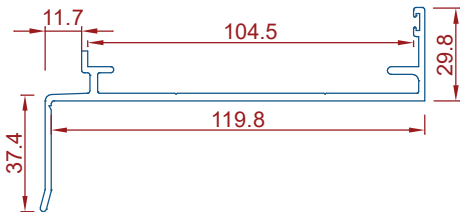

(Accepts: 101.6mm Frame & 100mm Thresholds, **CFH13**, **CFH13D**)

Length	Offered Finishes
6.5mtr	Mill / Natural Anodised / Powdercoated

CF431R - 131mm Slotted Subsill (23mm)

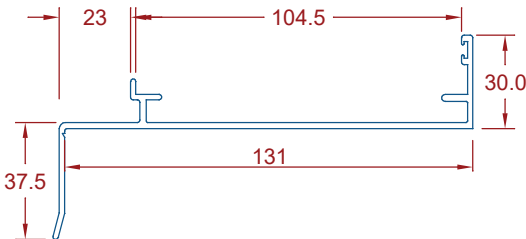

(Accepts: 101.6mm Frame & 100mm Thresholds, **CFH13**, **CFH13D**)

Length	Offered Finishes
6.5mtr	Mill / Natural Anodised / Powdercoated

CF462 - 144mm Slotted Subsill (36mm)

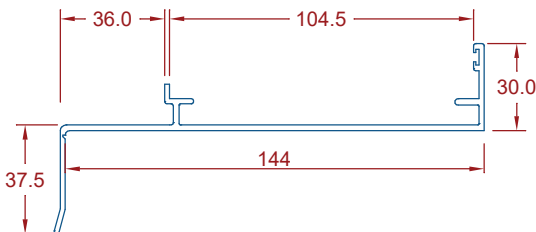

(Accepts: 101.6mm Frame & 100mm Thresholds, **CFH13**, **CFH13D**)

Length	Offered Finishes
6.5mtr	Mill / Natural Anodised / Powdercoated

Please note: Images are not to scale

100mm FRONT GLAZE COMMERCIAL SUITE (100mm x 50mm FRAME)

SUBSILL OPTIONS

CF462N - 148mm Slotted Subsill (36mm)

(Accepts: 101.6mm Frame & 100mm Thresholds, **CFH13**, **CFH13D**)

Length	Offered Finishes
6.5mtr	Mill / Natural Anodised / Powdercoated

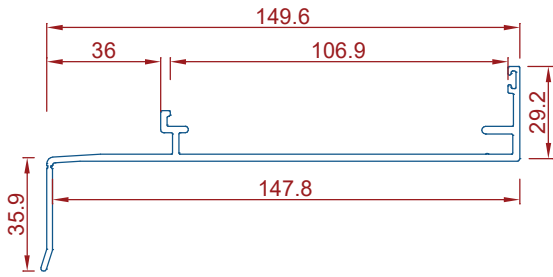

CF463N - 154mm Slotted Subsill (12mm)

(Accepts: 101.6mm Frame & 100mm Thresholds, **CFH13**, **CFH13D**)

Length	Offered Finishes
6.5mtr	Mill / Natural Anodised / Powdercoated

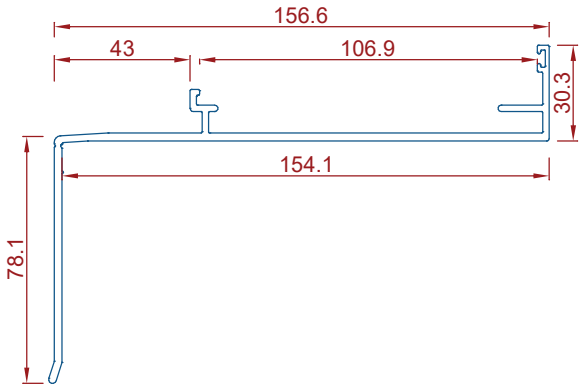

Please note: Images are not to scale

100mm FRONT GLAZE COMMERCIAL SUITE

DOOR SILL & THRESHOLD OPTIONS

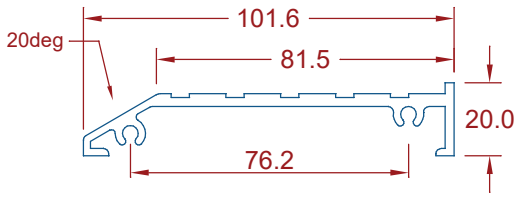

CF438 - Standard Threshold

(Suitable for 101.6mm Frames)

Length	Offered Finishes
6.5mtr	Mill / Natural Anodised / Powdercoated

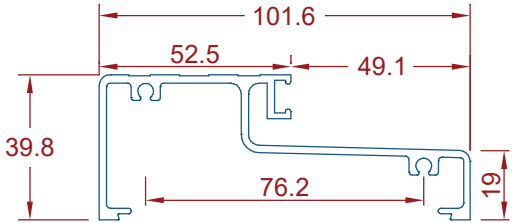

CF439 - Open Out Threshold

(Accepts: CFH4, CF405 & Suitable for 101.6mm Frames)

Length	Offered Finishes
6.5mtr	Mill / Natural Anodised / Powdercoated

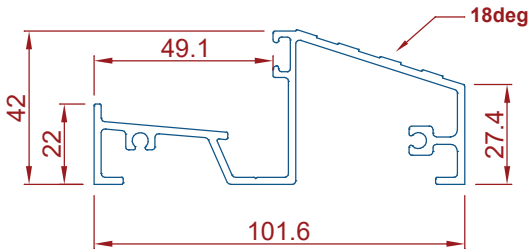

CF489 - Open In Threshold

(Accepts: CFH4 & Suitable for 101.6mm Frames)

Length	Offered Finishes
6.5mtr	Mill / Natural Anodised / Powdercoated

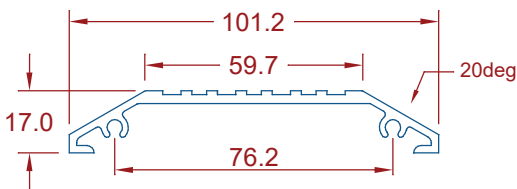

CF468 - Disabled Threshold

(Suitable for 101.6mm Frames)

Length	Offered Finishes
6.5mtr	Mill / Natural Anodised / Powdercoated

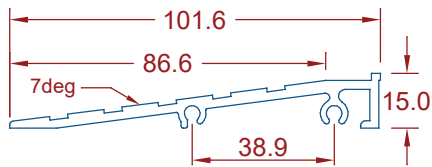

CF469 - Incline Wheelchair Threshold

(Suitable for 101.6mm Frames)

Length	Offered Finishes
6.5mtr	anodised / Powdercoated

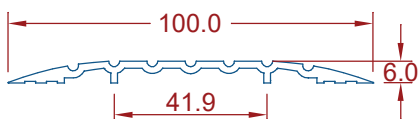

CF478 - Low Profile Threshold

(Suitable for 101.6mm Frames)

Length	Offered Finishes
4.0mtr	anodised / Powdercoated

Please note: Images are not to scale

150mm FRONT GLAZE COMMERCIAL SUITE

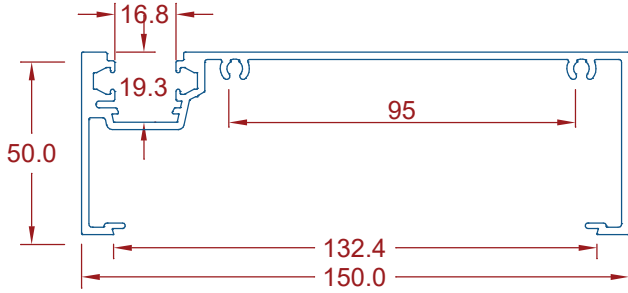

CF161CW - 150mm Frame

(Accepts: CF106, CF107, CF116, CF156, RA265)

(Accepts: **CFH015**)

Length	Offered Finishes
6.5mtr	Mill / Natural Anodised / Powdercoated

RA265 - Flat Filler

(Accepts: CF161CW, DG161, RA261, RA271)

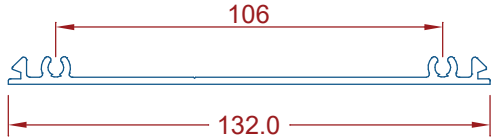

Length	Offered Finishes
6.5mtr	Mill / Natural Anodised / Powdercoated

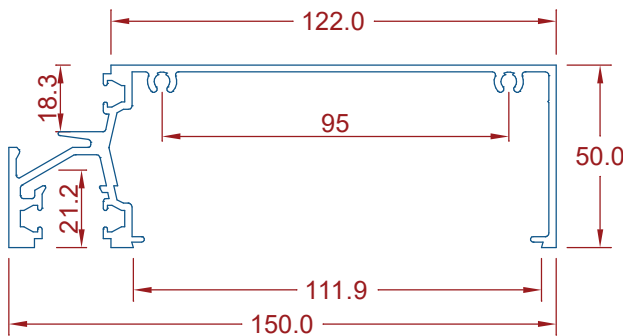

CF162CW - Transom/Sill (External Glazing)

(Accepts: CF104, CF106, CF165)

(Accepts: **CFH015**)

Length	Offered Finishes
6.5mtr	Mill / Natural Anodised / Powdercoated

CF104 - External Glazing Bead

(Accepts: CF102CW, CF162CW)

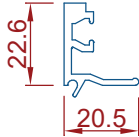

Length	Offered Finishes
6.5mtr	Mill / Natural Anodised / Powdercoated

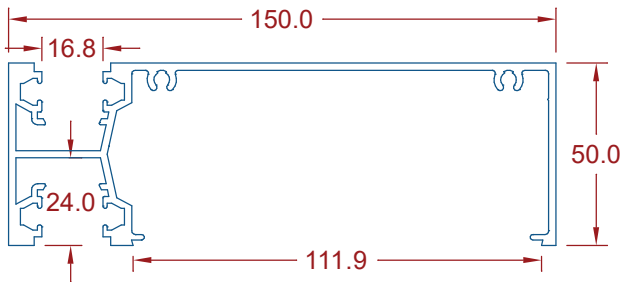

CF164CW - Head/Jamb Transom

(Accepts: CF106, CF165)

(Accepts: **CFH015**)

Length	Offered Finishes
6.5mtr	Mill / Natural Anodised / Powdercoated

CF165 - 150mm Internal Filler

(Accepts: CF162CW, CF164CW)



Length	Offered Finishes
6.5mtr	Mill / Natural Anodised / Powdercoated

CF106 - Single Glaze Pocket Filler

(Accepts: Most Front Glaze Single Glaze Pockets)

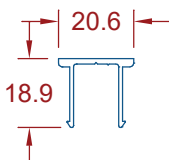

Length	Offered Finishes
6.5mtr	Mill / Natural Anodised / Powdercoated

Please note: Images are not to scale

150mm FRONT GLAZE COMMERCIAL SUITE

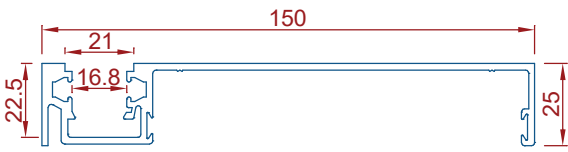

CF173CW - 150mm SG Female Mullion

(Accepts: CF106, CF107, CF116, CF156, CF174CW,)

(Accepts: **CFH015**)

Length	Offered Finishes
6.5mtr	Mill / Natural Anodised / Powdercoated



CF174CW - 150mm SG Male Mullion

(Accepts: CF106, CF107, CF116, CF156, CF173CW,)

(Accepts: **CFH015**)

Length	Offered Finishes
6.5mtr	Mill / Natural Anodised / Powdercoated

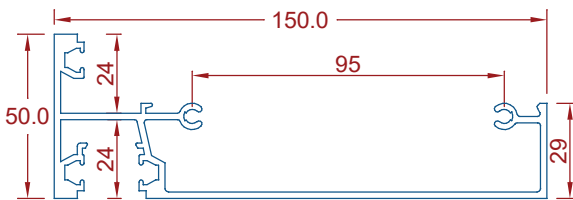

CF169CW - 150mm Internal Transom

(Accepts: CF106, CF170CW))

(Accepts: **CFH015**)

Length	Offered Finishes
6.5mtr	Mill / Natural Anodised / Powdercoated

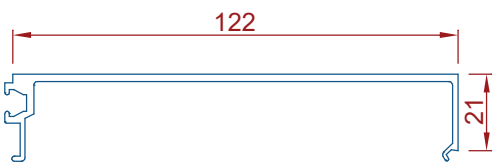

CF170CW - 150mm Internal Glazing Bead

(Accepts: CF169CW)

(Accepts: **CFH015**)

Length	Offered Finishes
6.5mtr	Mill / Natural Anodised / Powdercoated

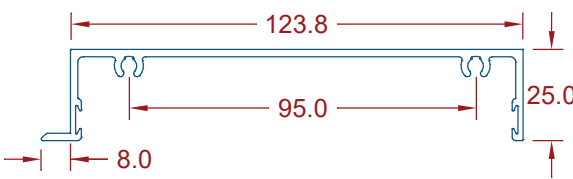

CF175 - 150mm Female Structural Mullion

(Accepts: CF176)

(Accepts: **CFH5** Mullion Seal)

Length	Offered Finishes
6.5mtr	Mill / Natural Anodised / Powdercoated

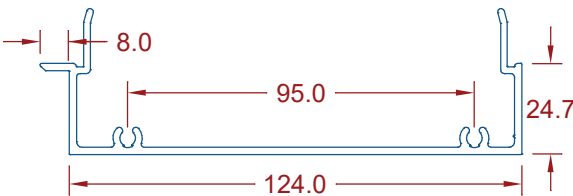

CF176 - 150mm Male Structural Split Mullion

(Accepts: CF175)

Length	Offered Finishes
6.5mtr	Mill / Natural Anodised / Powdercoated

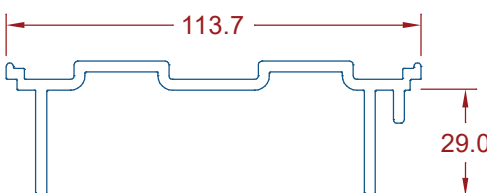

CF177 - 150mm Splice Bar

(Accepts: CF167CW/CF168CW, CF175/CF176)

Length	Offered Finishes
6.5mtr	Mill / Natural Anodised / Powdercoated

Please note: Images are not to scale

150mm FRONT GLAZE COMMERCIAL SUITE

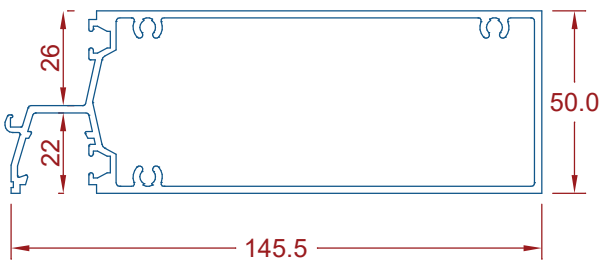

CF171CW - 150mm Cover Transom

(Accepts: CF106, DG117)

(Accepts: **CFH015**)

Length	Offered Finishes
6.5mtr	Mill / Natural Anodised / Powdercoated

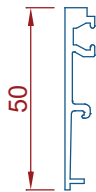

DG117 - Cover Bead

(Accepts: CF171CW)

Length	Offered Finishes
6.5mtr	Mill / Natural Anodised / Powdercoated



CF166 - 150mm Back to Back Adaptor

(Accepts: CF161CW, DG161, RA261, RA271)

Length	Offered Finishes
6.5mtr	Mill / Natural Anodised / Powdercoated

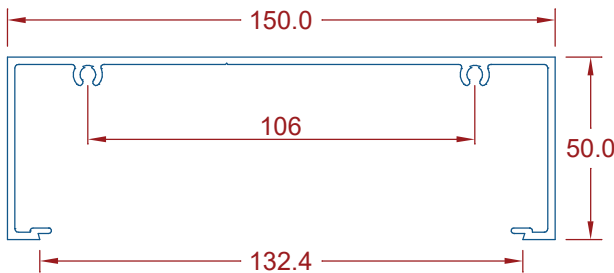

CF685 - 150mm Plain Frame

(Accepts: RA265)

Length	Offered Finishes
6.5mtr	Mill / Natural Anodised / Powdercoated

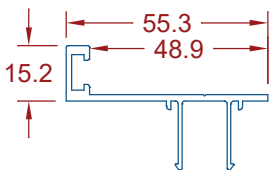

CF107 - 45mm Door Stop

(Accepts: CF176)

(Accepts: **CFH4** & **CFH11**)

Length	Offered Finishes
6.5mtr	anodised / Powdercoated

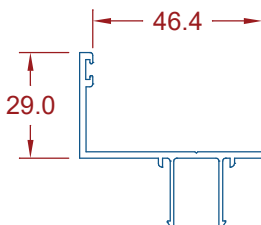

CF156 - 50mm Sash Stop

(Accepts: **CFH13** & Accepts most SG Front Glaze pockets)

Length	Offered Finishes
6.5mtr	Mill / Natural Anodised / Powdercoated

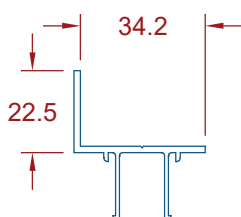

CF116 - 35mm Sash Stop

(Accepts: **CFH13** & Accepts most SG Front Glaze pockets)

Length	Offered Finishes
6.5mtr	Mill / Natural Anodised / Powdercoated

Please note: Images are not to scale

150mm FRONT GLAZE COMMERCIAL SUITE

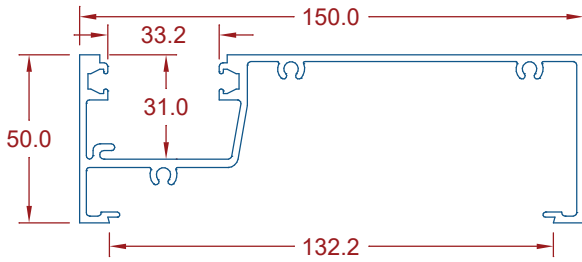

DG161 - 150mm DG Frame

(Accepts: DG105, DG107, DG116, DG156, DG201, RA265)

(Accepts: **CFH015**)

Length	Offered Finishes
6.5mtr	Mill / Natural Anodised / Powdercoated

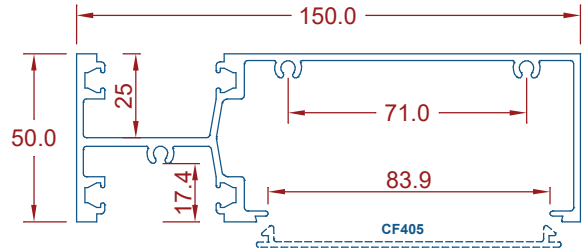

DG164 - 150mm DG Mullion (One Piece)

(Accepts: CF405, DG105, DG107, DG116, DG156, DG201)

(Accepts: **CFH015**)

Length	Offered Finishes
6.5mtr	Mill / Natural Anodised / Powdercoated

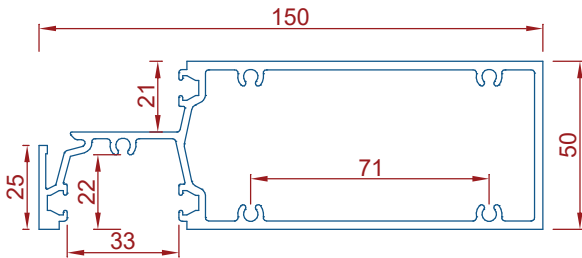

DG172 - 150mm DG Transom (External Bead)

(Accepts: DG106, DG113, DG116, DG156, DG201)

(Accepts: **CFH015**)

Length	Offered Finishes
6.5mtr	Mill / Natural Anodised / Powdercoated



DG113 - DG FG External Bead

(Accepts: DG172)

Length	Offered Finishes
6.5mtr	Mill / Natural Anodised / Powdercoated

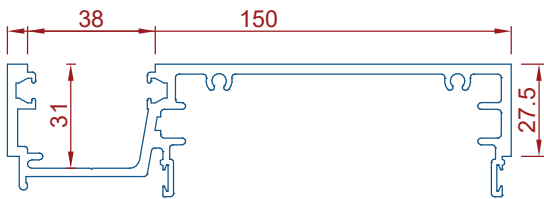

DG168 - 150mm DG Male Split Mullion

(Accepts: DG105, DG107, DG116, DG156, DG201, FB055)

(Accepts: **CFH015**, **CFH5** Mullion Seal)

Length	Offered Finishes
6.5mtr	Mill / Natural Anodised / Powdercoated

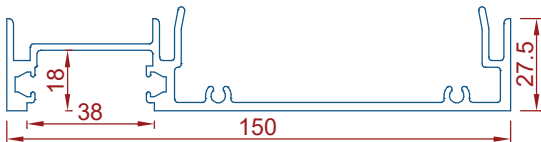

DG167 - 150mm DG Female Split Mullion

(Accepts: DG105, DG107, DG116, DG156, DG201)

(Accepts: **CFH015**, **CFH5** Mullion Seal)

Length	Offered Finishes
6.5mtr	Mill / Natural Anodised / Powdercoated

RA265 - Flat Filler

(Accepts: CF161CW, CF685, DG161, RA261, RA271)



Length	Offered Finishes
6.5mtr	Mill / Natural Anodised / Powdercoated

Please note: Images are not to scale

150mm FRONT GLAZE COMMERCIAL SUITE

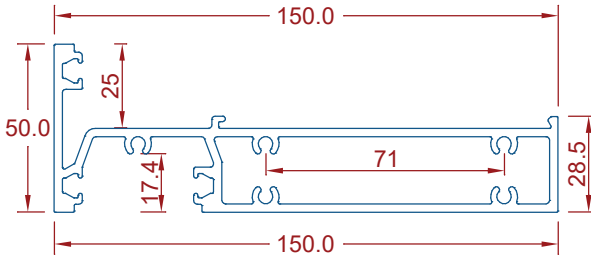

DG169 - 150mm DG Internal Transom

(Accepts: DG105, DG107, DG116, DG156, DG170, DG201)

(Accepts: **CFH015**)

Length	Offered Finishes
6.5mtr	Mill / Natural Anodised / Powdercoated

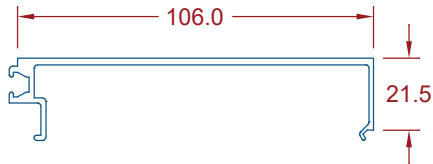

DG170 - 150mm DG Internal Glazing Bead

(Accepts: DG169)

(Accepts: **CFH015**)

Length	Offered Finishes
6.5mtr	Mill / Natural Anodised / Powdercoated

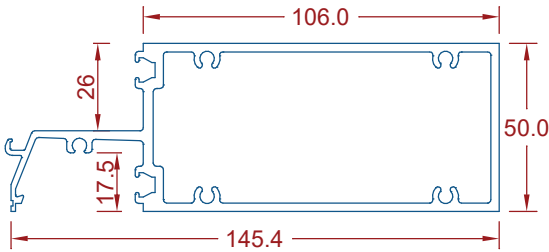

DG171 - 150mm DG Cover Transom (Face Bead)

(Accepts: DG117, DG105, DG107, DG116, DG156, DG201)

(Accepts: **CFH015**)

Length	Offered Finishes
6.5mtr	Mill / Natural Anodised / Powdercoated

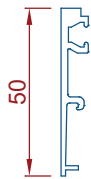

DG117 - Cover Bead

(Accepts: CF110CW, CF171CW, DG171)

(Accepts: **CFH015**)

Length	Offered Finishes
6.5mtr	Mill / Natural Anodised / Powdercoated



DG201 - DG Pocket Infill (Create SG Pocket)

(Accepts: **CFH015**) Suits 100mm & 150mm DG Pockets

Length	Offered Finishes
6.5mtr	Mill / Natural Anodised / Powdercoated

Please note: Images are not to scale

150mm FRONT GLAZE COMMERCIAL SUITE



DG106 - Pocket Filler

(Accepts: DG101, DG108, DG110, DG114, DG127, DG128, DG122, DG123, DG161, DG162, DG163, DG164, DG167, DG168, DG169, DG171)

Length	Offered Finishes
6.5mtr	Mill / Natural Anodised / Powdercoated

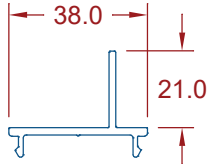

DG116 - 35mm Sash Stop

(Accepts: MOST DG FRONT GLAZE SECTIONS)

Length	Offered Finishes
6.5mtr	Mill / Natural Anodised / Powdercoated

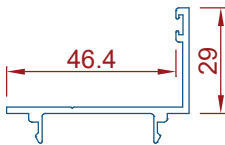

DG156 - 50mm Sash Stop

(Accepts: MOST DG FRONT GLAZE SECTIONS)

(Accepts: **CFH13**)

Length	Offered Finishes
6.5mtr	Mill / Natural Anodised / Powdercoated

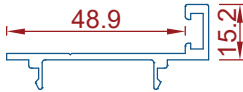

DG107 - 45mm Door Stop

(Accepts: MOST DG FRONT GLAZE SECTIONS)

(Accepts: **CFH4** & **CFH11**)

Length	Offered Finishes
6.5mtr	Mill / Natural Anodised / Powdercoated

Please note: Images are not to scale

600 SERIES CENTRE GLAZE (150mm FRAME)

SUBHEAD, SUBSILL & THRESHOLD OPTIONS

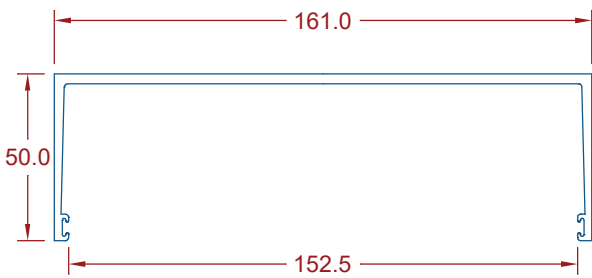

CF637 - 150mm Subhead

(Accepts: **CFH13** & **CFH13D**) Suits 150mm Frame

Length	Offered Finishes
6.5mtr	Mill / Natural Anodised / Powdercoated

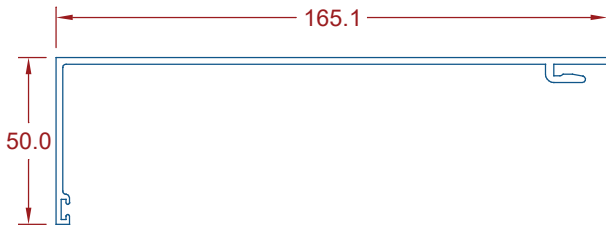

CF658 - 150mm Subhead 2 Piece

(Accepts: CF457) Suits 150mm Frame

(Accepts: **CFH5** Mullion Seal)

Length	Offered Finishes
6.5mtr	Mill / Natural Anodised / Powdercoated

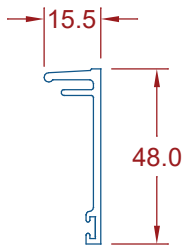

CF457 - 2 Piece Subhead Cover (50mm)

(Accepts: CF458, CF658)

(Accepts **CFH13** & **CFH13D**)

Length	Offered Finishes
6.5mtr	Mill / Natural Anodised / Powdercoated

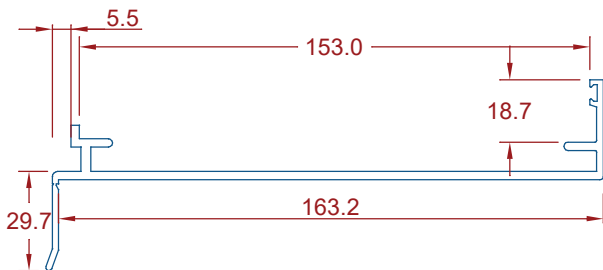

CF630 - 150mm Slotted Subsill

(Accepts: **CFH13** & **CFH13D**) Suits 150mm Frame

Length	Offered Finishes
6.5mtr	anodised / Powdercoated

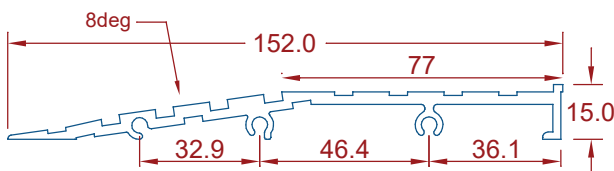

CF669 - 150mm Incline Wheelchair Threshold

Suits 150mm frame & inserts to CF630 Subsill

Length	Offered Finishes
6.5mtr	anodised / Powdercoated

Please note: Images are not to scale

FRONT GLAZE SYSTEM GLAZING DETAIL

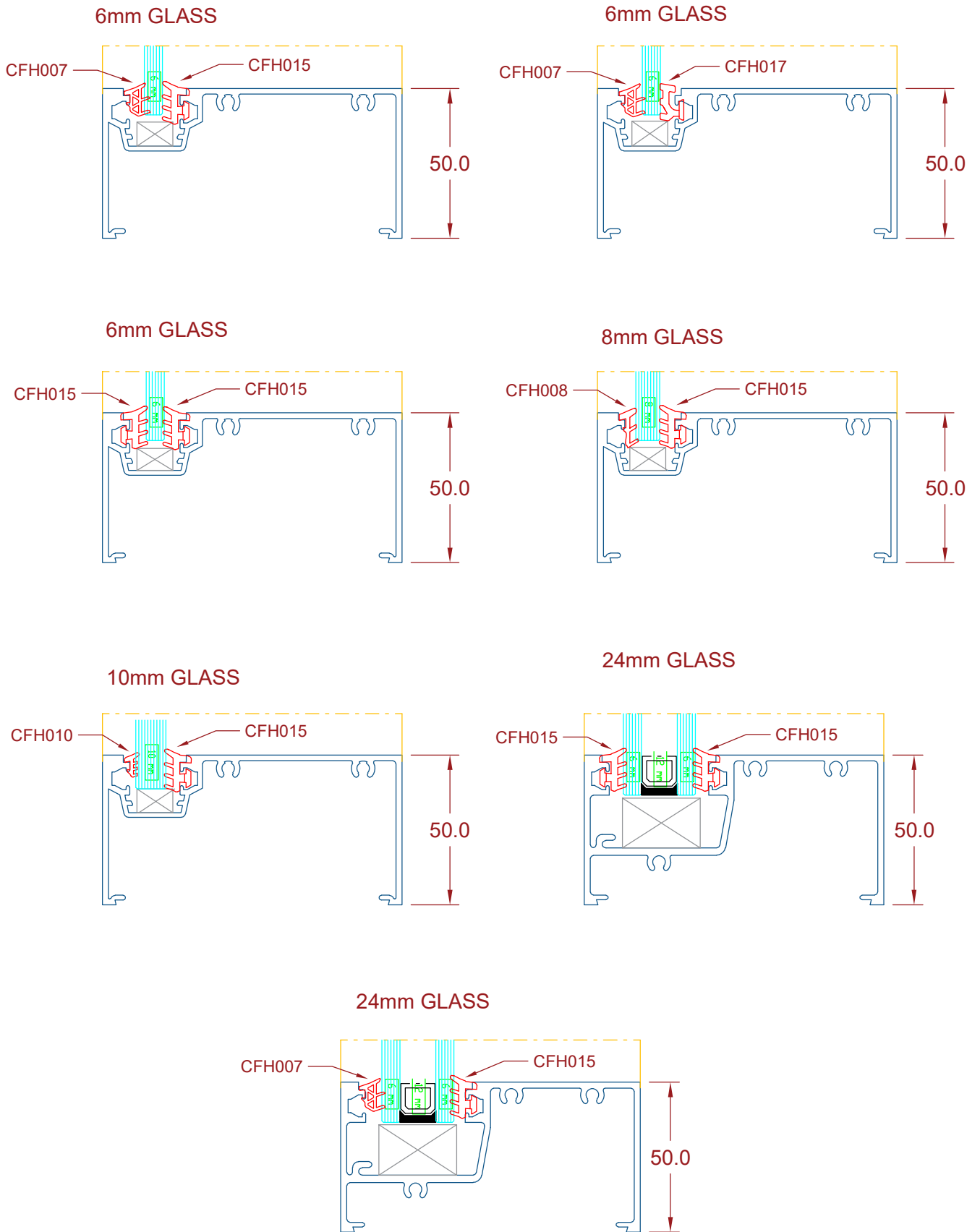

Please note: Images are not to scale

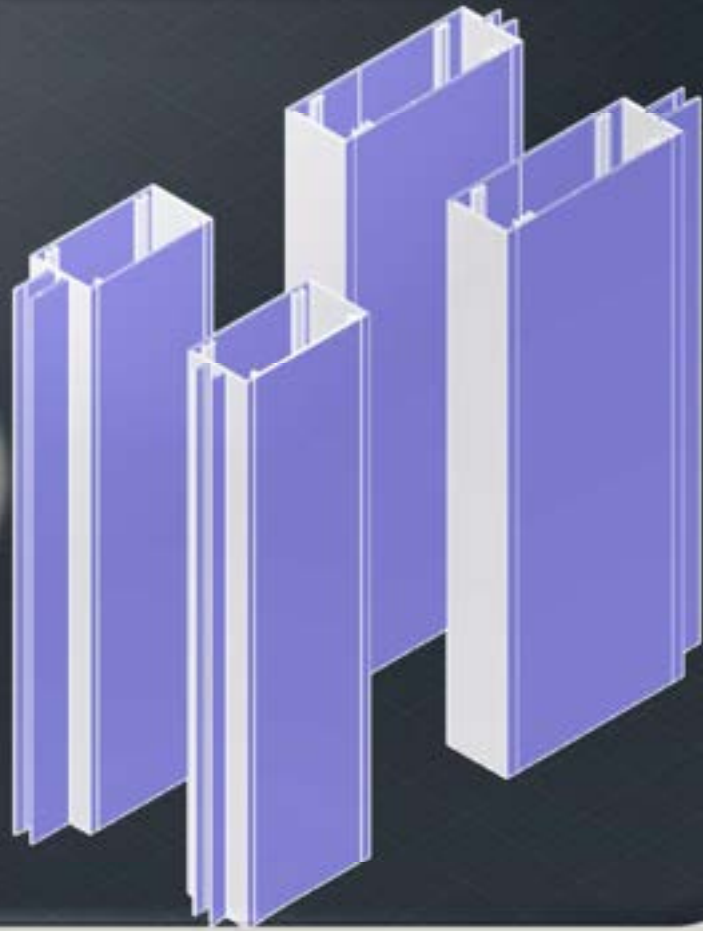
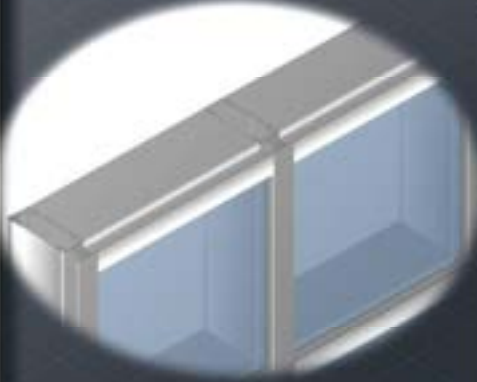

FLUSH GLAZE COMMERCIAL SUITE



This particular system is aesthetically sought after for most medium rise and shopfront use with its clean and modern external appearance. Glazing & Design features nearly flush with the outside face leaving as little of the aluminium profiles visibility externally. The flush glaze system can also be used as a curtain wall due to its design strength properties. Single and double glazed options along with 103mm and 150mm frame depths.

100mm FLUSH GLAZE COMMERCIAL SUITE

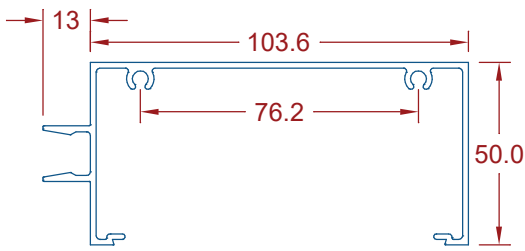

CF241 - SG Standard Frame

(Accepts: CF244, CF243, CF256, CF405)

Length	Offered Finishes
6.5mtr	Mill / Natural Anodised / Powdercoated

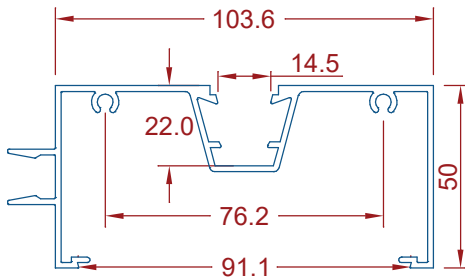

CF242 - SG Jamb/Pocketed Frame

(Accepts: CF244, CF243, CF256, CF405, CF406)

Length	Offered Finishes
6.5mtr	Mill / Natural Anodised / Powdercoated

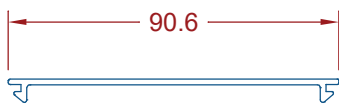

CF405 - Flat Filler

(Accepts: CF400, CF400B, CF401, CF402, CF418, CF436, CF8131, CF701, CF702, CF751, CF752, CF601, CF101CW, DG101, DG601)

Length	Offered Finishes
6.5mtr	Mill / Natural Anodised / Powdercoated



CF483 - HD Flat Filler with Screw Flutes

(Accepts: CF241, CF242, CF251)

Length	Offered Finishes
6.5mtr	Mill / Natural Anodised / Powdercoated

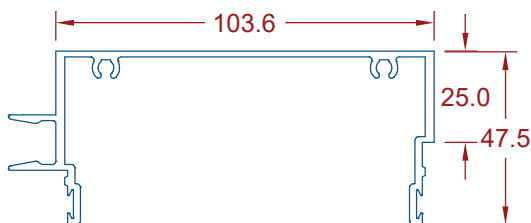

CF246 - SG Male Split Mullion

(Accepts: CF247, CF244, CF243, CF256)

(Accepts: **CFH5** Mullion Seal)

Length	Offered Finishes
6.5mtr	Mill / Natural Anodised / Powdercoated

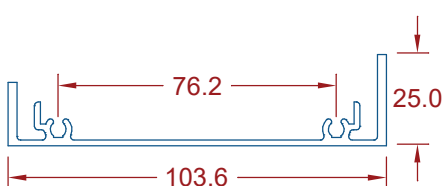

CF247 - Female Split Mullion

(Accepts: CF246)

Length	Offered Finishes
6.5mtr	Mill / Natural Anodised / Powdercoated

Please note: Images are not to scale

100mm FLUSH GLAZE COMMERCIAL SUITE

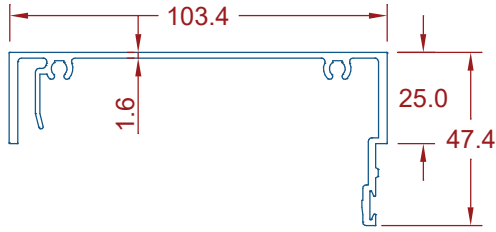

CF252 - Self Mating Mullion

(Accepts: CF244, CF243, CF256)

(Accepts: **CFH5** Mullion Seal)

Length	Offered Finishes
6.5mtr	Mill / Natural Anodised / Powdercoated

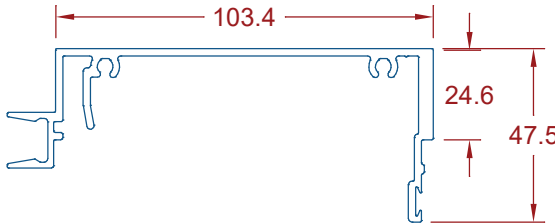

CF259 - SG HD Male Mullion

(Accepts: CF244, CF243, CF252, CF256)

(Accepts: **CFH5** Mullion Seal)

Length	Offered Finishes
6.5mtr	Mill / Natural Anodised / Powdercoated

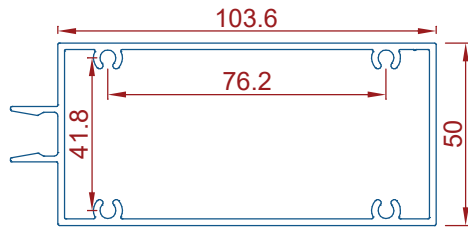

CF291 - SG Box Transom

(Accepts: CF244, CF243, CF256)

Length	Offered Finishes
6.5mtr	Mill / Natural Anodised / Powdercoated

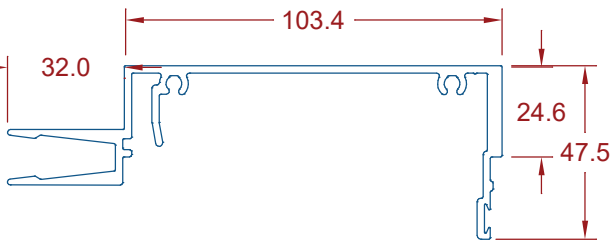

CF289 - DG HD Male Mullion

(Accepts: CF243, CF252, CF254, CF256)

(Accepts: **CFH5** Mullion Seal)

Length	Offered Finishes
6.5mtr	Mill / Natural Anodised / Powdercoated

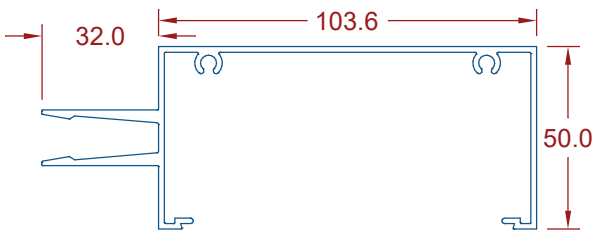

CF251 - DG Standard Frame

(Accepts: CF243, CF254, CF256, CF405)

Length	Offered Finishes
6.5mtr	Mill / Natural Anodised / Powdercoated

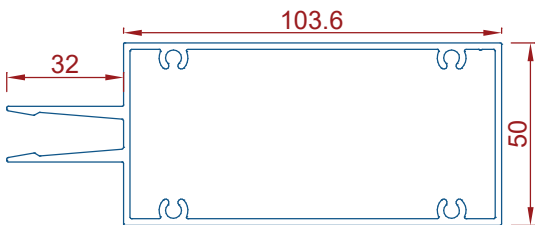

CF290 - DG Box Transom

(Accepts: CF243, CF254, CF256)

Length	Offered Finishes
6.5mtr	Mill / Natural Anodised / Powdercoated

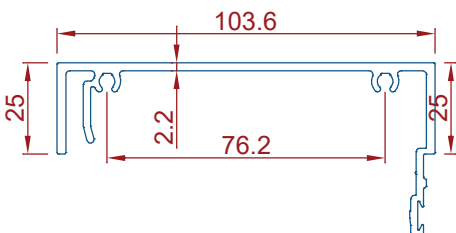

CF252HD - HD Self Mating Mullion

(Accepts: CF252, CF259, CF289)

(Accepts: **CFH5** Mullion Seal)

Length	Offered Finishes
6.5mtr	Mill / Natural Anodised / Powdercoated

Please note: Images are not to scale

100mm FLUSH GLAZE COMMERCIAL SUITE

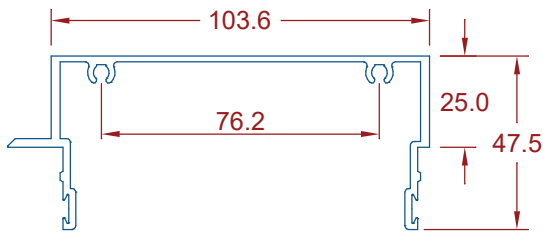

CF248 - Structural Male Mullion

(Accepts: CF249)

(Accepts: **CFH5** Mullion Seal)

Length	Offered Finishes
6.5mtr	Mill / Natural Anodised / Powdercoated



CF249 - Structural Female Mullion

(Accepts: CF248)

Length	Offered Finishes
6.5mtr	Mill / Natural Anodised / Powdercoated

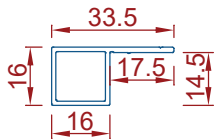

CF292 - Spandrel Adaptor

Length	Offered Finishes
6.5mtr	Mill / Natural Anodised / Powdercoated

Please note: Images are not to scale

100mm FLUSH GLAZE COMMERCIAL SUITE

FLUSH GLAZE SUITE - SUBSILL & SUBHEAD OPTIONS (100mm FRAME)

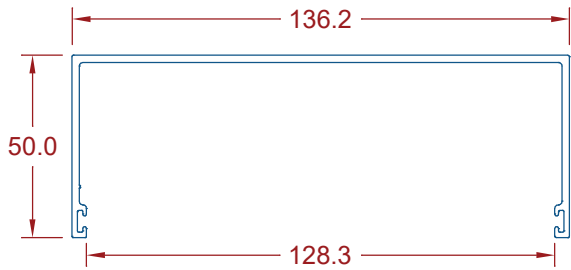

CF261 - SG Flush Glaze Subhead

(Accepts: 100mm Flush Glaze Frames)
(Accepts: **CFH13** & **CFH13D** Bulb Seal)

Length	Offered Finishes
6.5mtr	Mill / Natural Anodised / Powdercoated

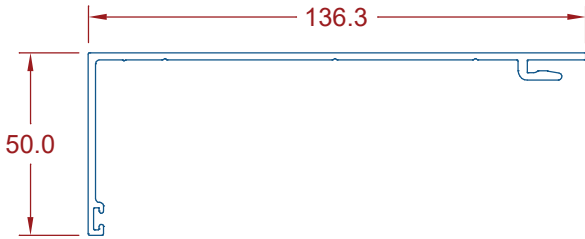

CF480 - 2 Piece Flush Glaze Subhead

(Accepts: CF457)
(Accepts: **CFH13** & **CFH13D** Bulb Seal)

Length	Offered Finishes
6.5mtr	Mill / Natural Anodised / Powdercoated

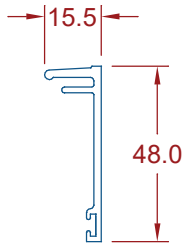

CF457 - 2 Piece Subhead Cover (Pressure Bead)

(Accepts: CF458, CF658)
(Accepts: **CFH13** & **CFH13D**)

Length	Offered Finishes
6.5mtr	Mill / Natural Anodised / Powdercoated

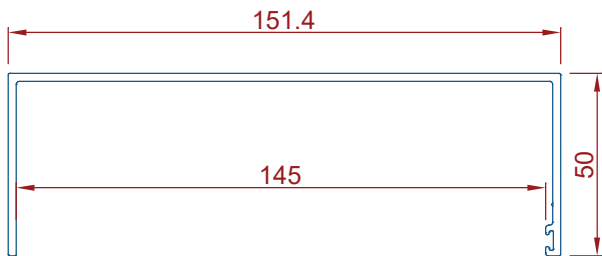

CF277 - DG Flush Glaze Subhead

(Accepts: 100mm Flush Glaze Frames)
(Accepts: **CFH13** & **CFH13D** Bulb Seal)

Length	Offered Finishes
6.5mtr	Mill / Natural Anodised / Powdercoated

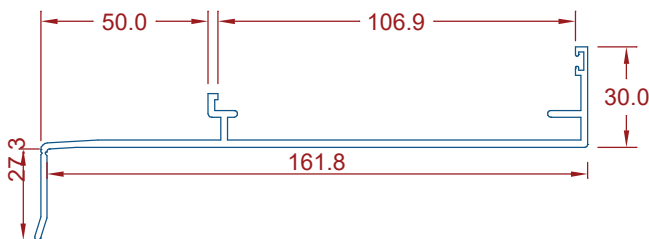

CF4462N - SG Flush Glaze Slotted Subsill

(Accepts: 100mm Flush Glaze Frames)
(Accepts: **CFH13** & **CFH13D** Bulb Seal)

Length	Offered Finishes
6.5mtr	Mill / Natural Anodised / Powdercoated

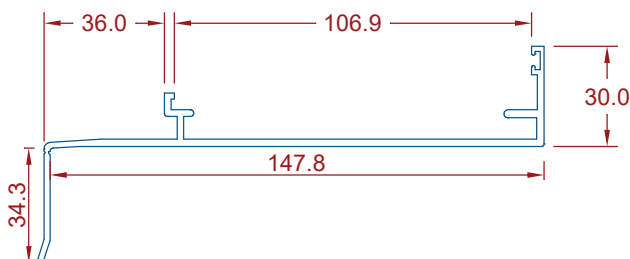

CF479 - DG Flush Glaze Slotted Subsill

(Accepts: 100mm Flush Glaze Frames)
(Accepts: **CFH13** & **CFH13D** Bulb Seal)

Length	Offered Finishes
6.5mtr	Mill / Natural Anodised / Powdercoated

Please note: Images are not to scale

150mm FLUSH GLAZE COMMERCIAL SUITE

RA261 - 150mm Frame

(Accepts: CF244, CF243, CF256, RA265)

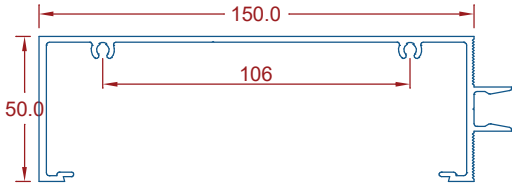

Length	Offered Finishes
6.5mtr	Mill / Natural Anodised / Powdercoated

RA265 - Flat Filler

(Accepts: CF161CW, CF685, DG161, RA261, RA271)



Length	Offered Finishes
6.5mtr	Mill / Natural Anodised / Powdercoated

RA262 - SG Box Transom

(Accepts: CF244, CF243, CF256)

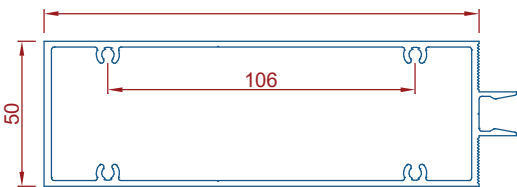

Length	Offered Finishes
6.5mtr	Mill / Natural Anodised / Powdercoated

RA266 - 150mm Female Split Mullion

(Accepts: RA267)

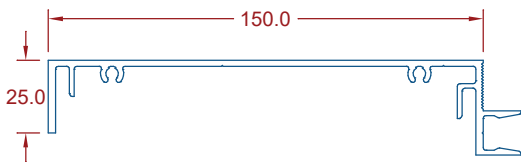

Length	Offered Finishes
6.5mtr	Mill / Natural Anodised / Powdercoated

RA267 - 150mm Male Split Mullion

(Accepts: RA266)

(Accepts: CFH5 Mullion Seal)

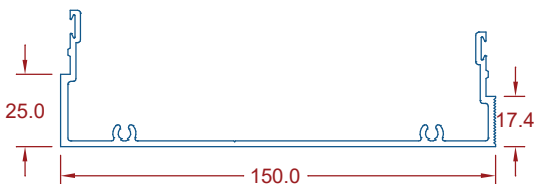

Length	Offered Finishes
6.5mtr	Mill / Natural Anodised / Powdercoated

Please note: Images are not to scale

150mm FLUSH GLAZE COMMERCIAL SUITE

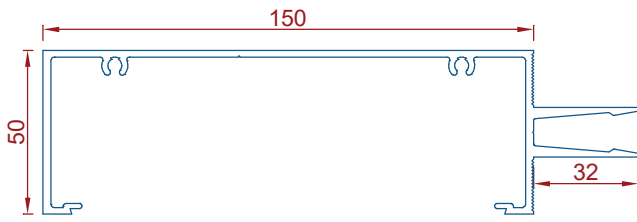

RA271 - 150mm DG Frame

(Accepts: CF243, CF254, CF256, RA265)

Length	Offered Finishes
6.5mtr	Mill / Natural Anodised / Powdercoated

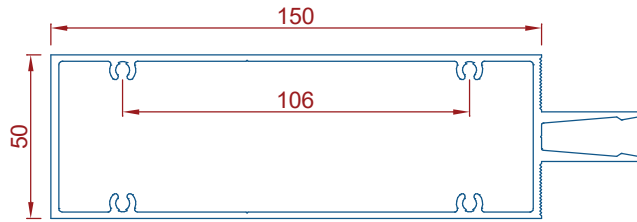

RA272 - DG Box Transom

(Accepts: CF243, CF254, CF256)

Length	Offered Finishes
6.5mtr	Mill / Natural Anodised / Powdercoated

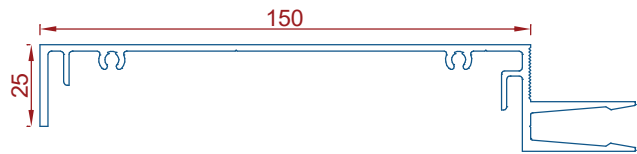

RA276 - 150mm DG Female Split Mullion

(Accepts: CF243, CF254, CF256, RA267)

Length	Offered Finishes
6.5mtr	Mill / Natural Anodised / Powdercoated

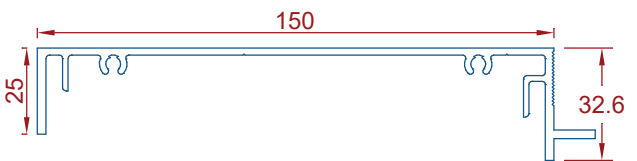

RA268 - 150mm Blind Female Split Mullion

(Accepts: RA267)

Length	Offered Finishes
6.5mtr	Mill / Natural Anodised / Powdercoated

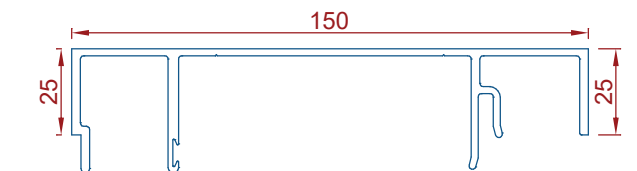

CF652 - 150mm Self Mating Mullion

(Accepts: CF652)

Length	Offered Finishes
6.5mtr	Mill / Natural Anodised / Powdercoated

Please note: Images are not to scale

150mm FLUSH GLAZE COMMERCIAL SUITE

FLUSH GLAZE SUITE - SUBSILL & SUBHEAD OPTIONS (150mm FRAME)

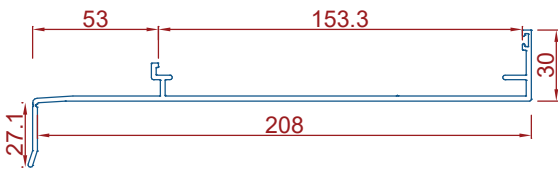

RA278 - DG Flush Glaze Slotted Subsill

(Accepts: 150mm Flush Glaze Frames)

(Accepts: **CFH13** & **CFH13D** Bulb Seal)

Length	Offered Finishes
6.5mtr	Mill / Natural Anodised / Powdercoated

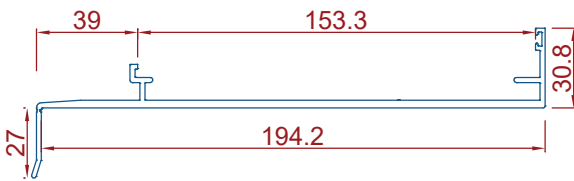

RA279 - SG Flush Glaze Slotted Subsill

(Accepts: 150mm Flush Glaze Frames)

(Accepts: **CFH13** & **CFH13D** Bulb Seal)

Length	Offered Finishes
6.5mtr	Mill / Natural Anodised / Powdercoated

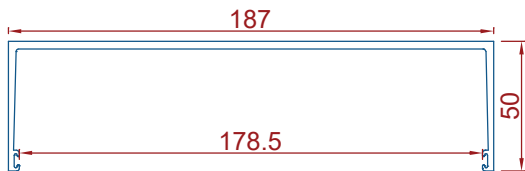

RA280 - SG Flush Glaze Subhead

(Accepts: 150mm Flush Glaze Frames)

(Accepts: **CFH13** & **CFH13D** Bulb Seal)

Length	Offered Finishes
6.5mtr	Mill / Natural Anodised / Powdercoated

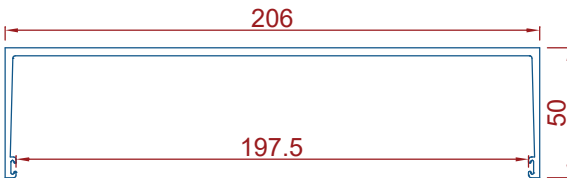

RA281 - DG Flush Glaze Subhead

(Accepts: 150mm Flush Glaze Frames)

(Accepts: **CFH13** & **CFH13D** Bulb Seal)

Length	Offered Finishes
6.5mtr	Mill / Natural Anodised / Powdercoated

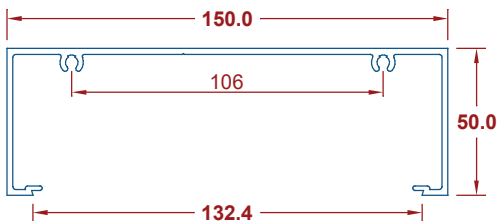

CF685 - 150mm Plain Frame

(Accepts: RA265 Flat Filler)

Length	Offered Finishes
6.5mtr	Mill / Natural Anodised / Powdercoated

Please note: Images are not to scale

FLUSH GLAZE COMMERCIAL SUITE

FLUSH GLAZE SUITE - SNAP ON COVERS & STOPS

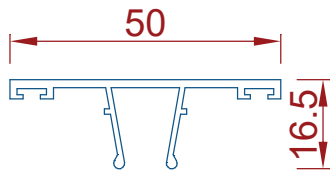

CF243 - 16mm Snap Cover

(Accepts: CF241, CF242, CF246, CF259, CF291, RA261, RA262, RA266) (Accepts: **CFH016** Captive Wedge)

Length	Offered Finishes
6.5mtr	Mill / Natural Anodised / Powdercoated

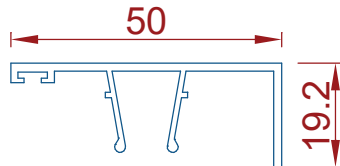

CF244 - 16mm Snap Return Cover

(Accepts: CF241, CF242, CF246, CF259, CF291, RA261, RA262, RA266) (Accepts: **CFH016** Captive Wedge)

Length	Offered Finishes
6.5mtr	Mill / Natural Anodised / Powdercoated

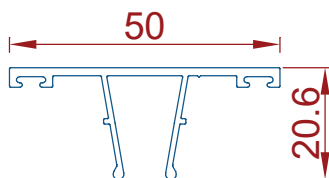

CF256 - 20mm Snap Cover

(Accepts: CF241, CF242, CF246, CF259, CF291, RA261, RA262, RA266) (Accepts: **CFH016** Captive Wedge)

Length	Offered Finishes
6.5mtr	Mill / Natural Anodised / Powdercoated

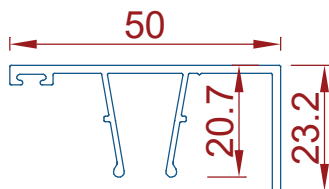

CF257 - 20mm Snap Return Cover

(Accepts: CF251, CF289, CF290, RA271, RA272, RA276) (Accepts: **CFH016** Captive Wedge)

Length	Offered Finishes
6.5mtr	Mill / Natural Anodised / Powdercoated

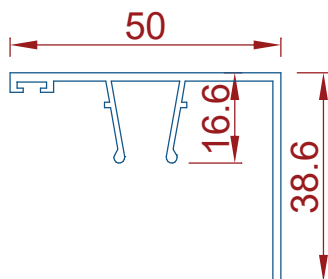

CF254 - 16mm DG Return Cover

(Accepts: CF251, CF289, CF290, RA271, RA272, RA276) (Accepts: **CFH016** Captive Wedge)

Length	Offered Finishes
6.5mtr	Mill / Natural Anodised / Powdercoated

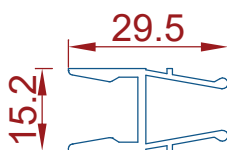

CF253 - DG Adaptor

(Accepts: CF241, CF242, CF246, CF259, CF291, RA261, RA262, RA266)

Length	Offered Finishes
6.5mtr	Mill / Natural Anodised / Powdercoated

Please note: Images are not to scale

FLUSH GLAZE COMMERCIAL SUITE

FLUSH GLAZE SUITE - GLAZING BASES & STOPS

CF250 - Plant On Base

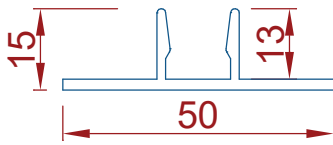

Length	Offered Finishes
6.5mtr	Mill / Natural Anodised / Powdercoated

CF260 - DG Plant On Base

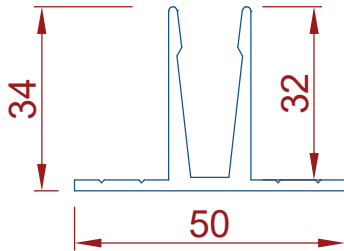

Length	Offered Finishes
6.5mtr	Mill / Natural Anodised / Powdercoated

Please note: Images are not to scale

FLUSH GLAZE COMMERCIAL SUITE GLAZING & CAPPING DETAIL

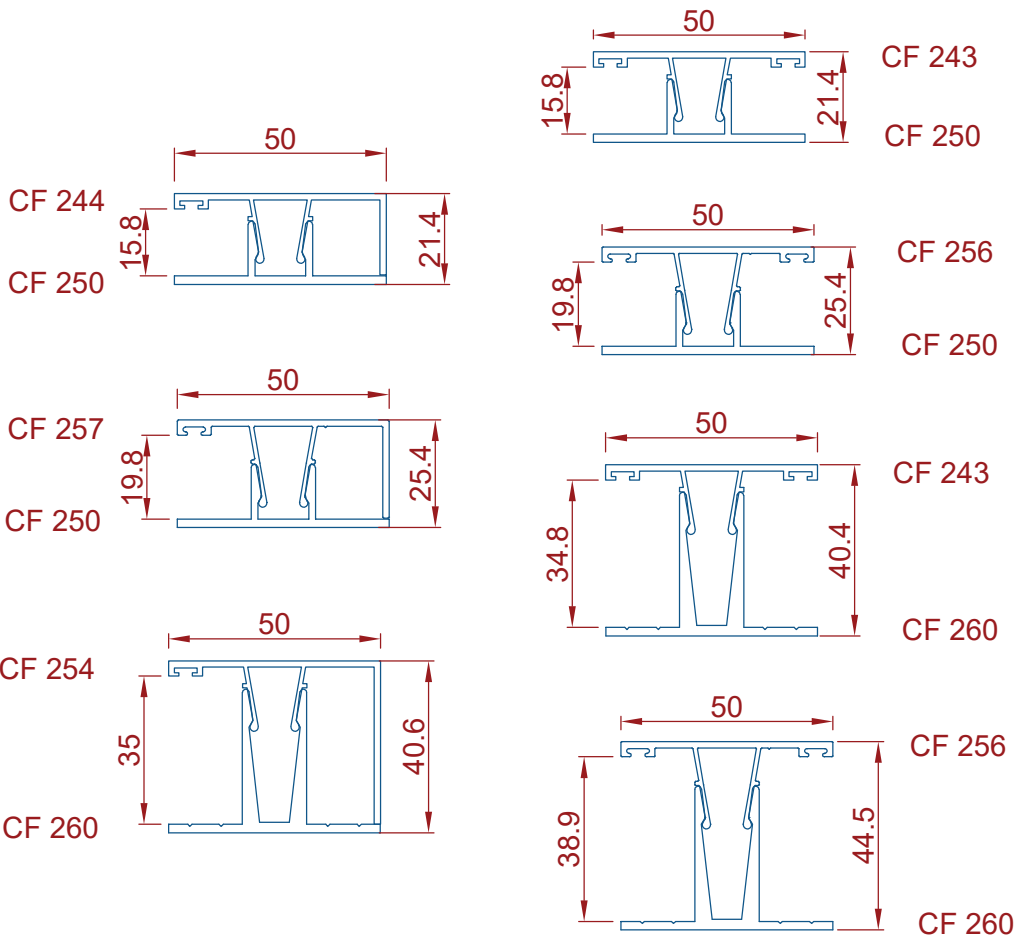
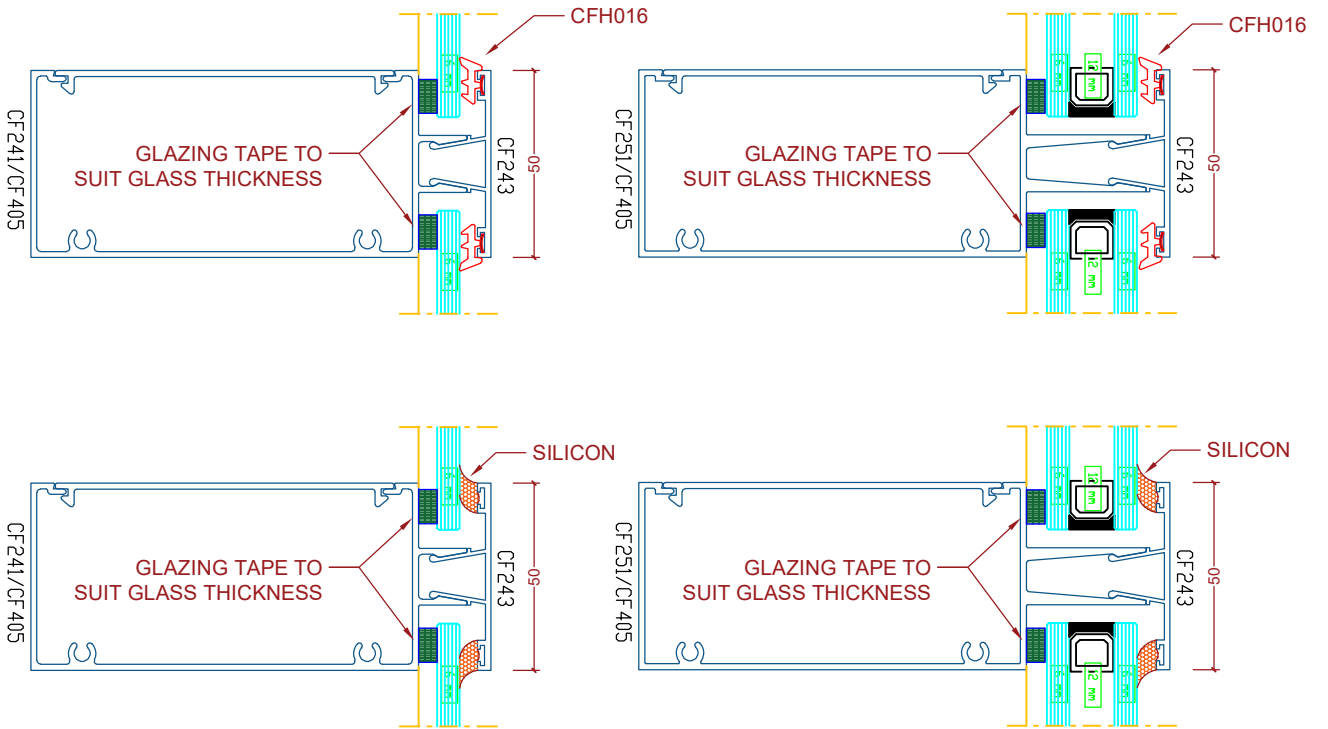

Please note: Images are not to scale

NOTES

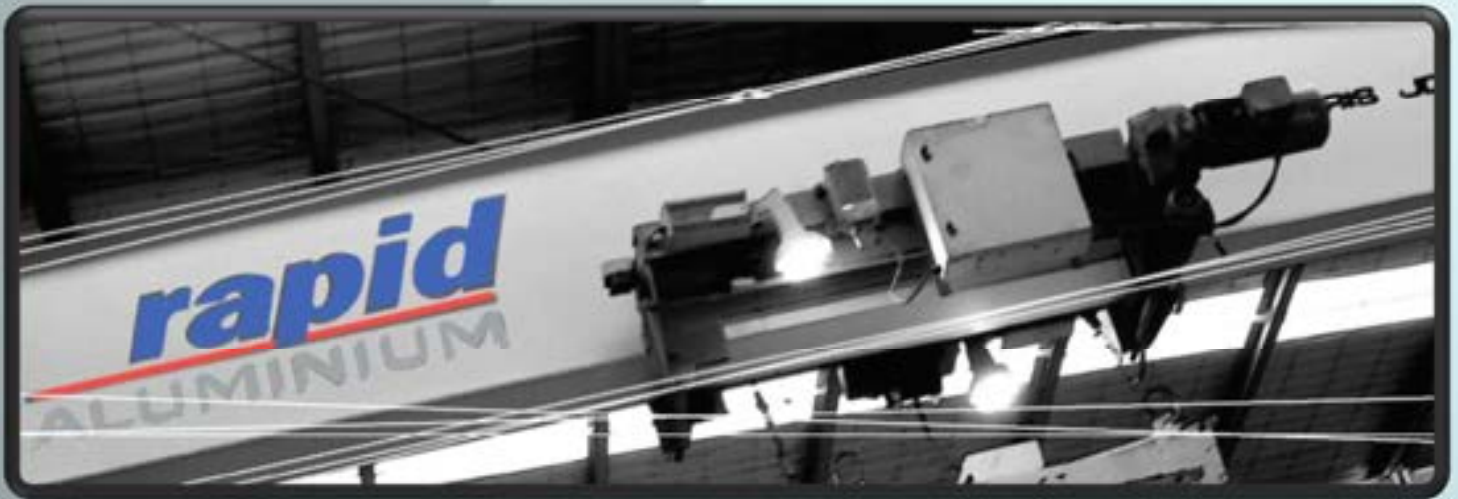

INSERTIONS: NESTED FRAMES, SEALS & HARDWARE

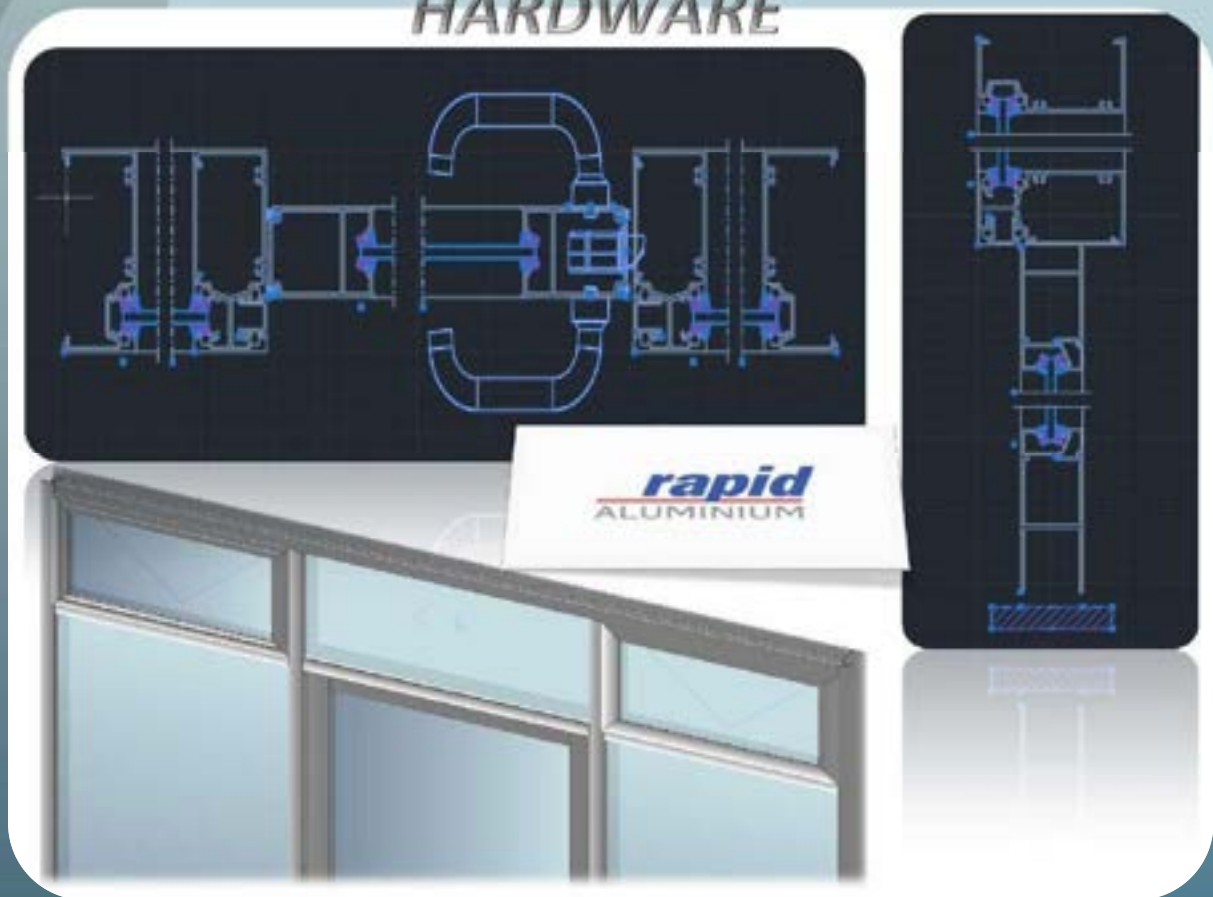

1. Awning/Casement Sashes
2. Commercial Doors
3. Commercial Fixed Louvres
4. Hardware, Components, Gaskets & Seals

INSERTIONS: AWNING/CASEMENT SASHES

35mm AWNING/CASEMENT SASHES (SG & DG)

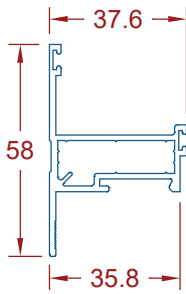

CF415 - 35mm Grooved Awning Sash

(Accepts: CF016, CF417)

(Accepts: **CFH13** & **CFH13D** Mullion Seal & **CFH3** Corner Stake)

Length	Offered Finishes
6.5mtr	Mill / Natural Anodised / Powdercoated

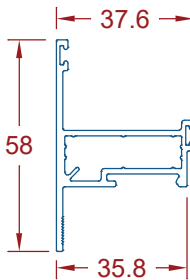

CF415B - 35mm Flat Awning Sash

(Accepts: CF016, CF417)

(Accepts: **CFH13** & **CFH13D** Mullion Seal & **CFH3** Corner Stake)

Length	Offered Finishes
6.5mtr	Mill / Natural Anodised / Powdercoated

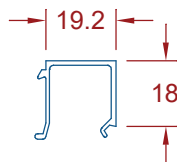

CF417 - Sash Bead

(Accepts: CF415, CF415B, CF4515, CF475, CF475B)

Length	Offered Finishes
6.5mtr	Mill / Natural Anodised / Powdercoated

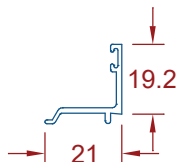

CF016 - DG Sash Bead

(Accepts: CF415, CF415B, CF4515, CF475, CF475B)

Length	Offered Finishes
6.5mtr	Mill / Natural Anodised / Powdercoated

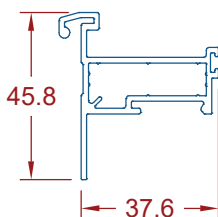

CF475 - 35mm Grooved Awning Sash with Hinge

(Accepts: CF016, CF417)

(Accepts: **CFH13** & **CFH13D** Mullion Seal & **CFH3** Corner Stake)

Length	Offered Finishes
6.5mtr	Mill / Natural Anodised / Powdercoated

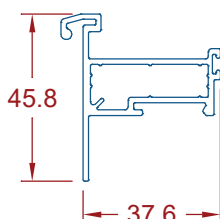

CF475B - 35mm Flat Awning Sash with Hinge

(Accepts: CF016, CF417)

(Accepts: **CFH13** & **CFH13D** Mullion Seal & **CFH3** Corner Stake)

Length	Offered Finishes
6.5mtr	Mill / Natural Anodised / Powdercoated

Please note: Images are not to scale

INSERTIONS: AWNING/CASEMENT SASHES

35mm AWNING/CASEMENT SASHES

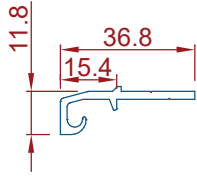

CF460H - Sash Hinge

(Accepts: CF475 & CF475B)

Length	Offered Finishes
6.5mtr	Mill / Natural Anodised / Powdercoated

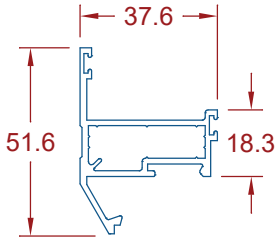

CF435 - 35mm Sloping Awning Sash (SG only)

(Accepts: CF414)

(Accepts: **CFH13** & **CFH13D** Mullion Seal & **CFH3** Corner Stake)

Length	Offered Finishes
6.5mtr	Mill / Natural Anodised / Powdercoated

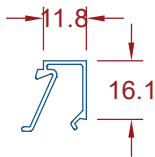

CF414 - Sash Bead

(Accepts: CF435)

Length	Offered Finishes
6.5mtr	Mill / Natural Anodised / Powdercoated

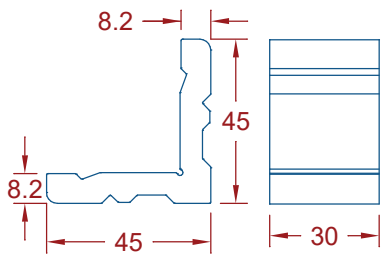

CFH3 - 35mm Corner Stake

(Accepts: CF415, CF415B, CF435, CF475, CF475B)

QTY	Offered Finishes
EACH	Mill Finish

Please note: Images are not to scale

INSERTIONS: AWNING/CASEMENT SASHES

50mm AWNING/CASEMENT SASHES (SG & DG)

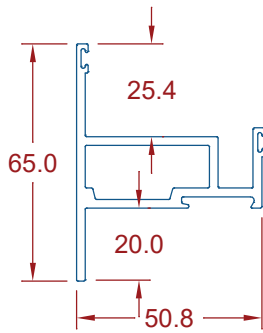

CF4515 - 50mm Awning Sash

(Accepts: CF016, CF417, CF4517)

(Accepts: **CFH13** & **CFH13D** Mullion Seal & **CFH50** Corner Stake)

Length	Offered Finishes
6.5mtr	Mill / Natural Anodised / Powdercoated

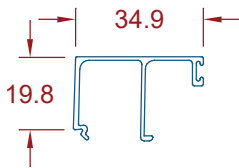

CF4517 - 50mm Sash Bead

(Accepts: CF4515, **CFH13** & **CFH13D**)

Length	Offered Finishes
6.5mtr	Mill / Natural Anodised / Powdercoated

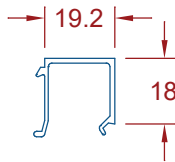

CF417 - Sash Bead

(Accepts: CF415, CF415B, CF4515, CF475, CF475B)

Length	Offered Finishes
6.5mtr	Mill / Natural Anodised / Powdercoated

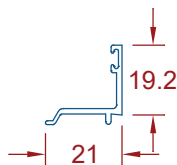

CF016 - DG Sash Bead

(Accepts: CF415, CF415B, CF4515, CF475, CF475B)

(Accepts: **CFH13** & **CFH13D**)

Length	Offered Finishes
6.5mtr	Mill / Natural Anodised / Powdercoated

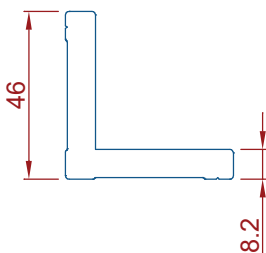

CFH50 - 50mm Corner Stake

(Accepts: CF4515)

QTY	Offered Finishes
Each	Mill Finish

Please note: Images are not to scale

Awning Sash Guides & Drawings

35mm SASH

6mm GLASS

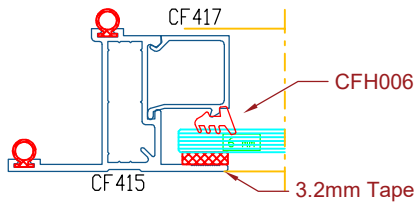

8mm GLASS

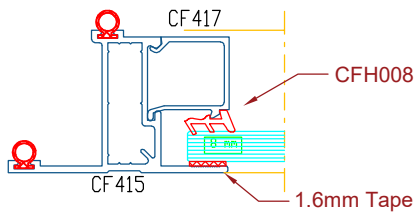

10mm GLASS

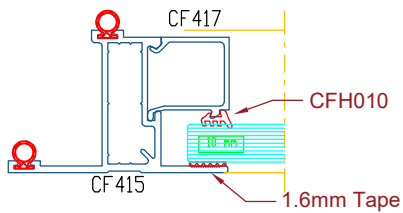

6/12/6mm GLASS

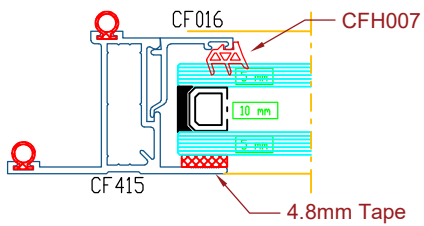

6/12/6mm GLASS

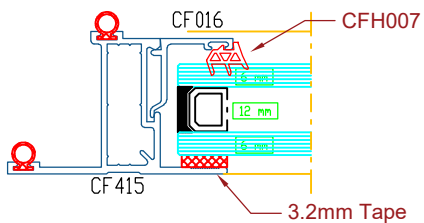

50mm SASH

6mm GLASS

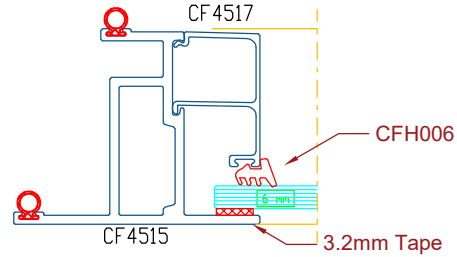

10mm GLASS

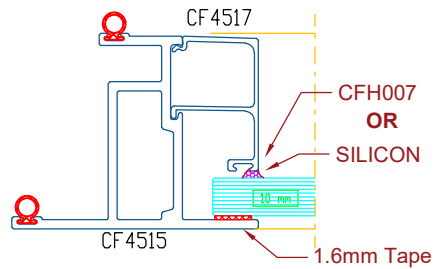

5/8/5mm GLASS

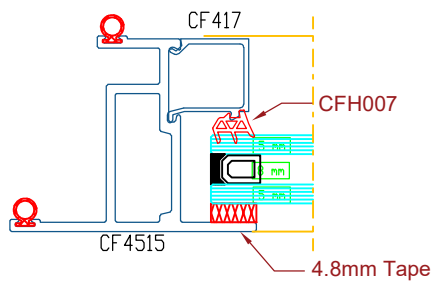

5/10/5mm GLASS

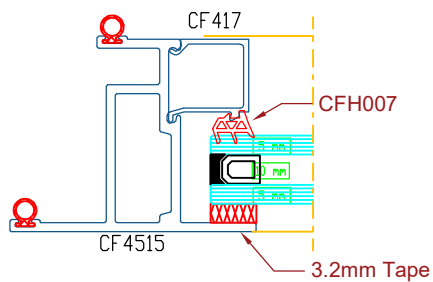

6/12/6mm GLASS

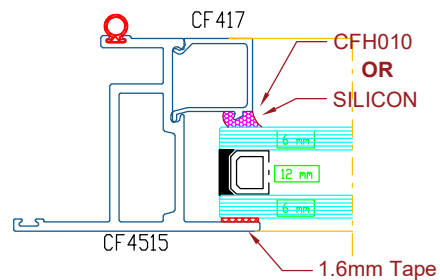

Please note: Images are not to scale

Awning Sash Guides & Drawings

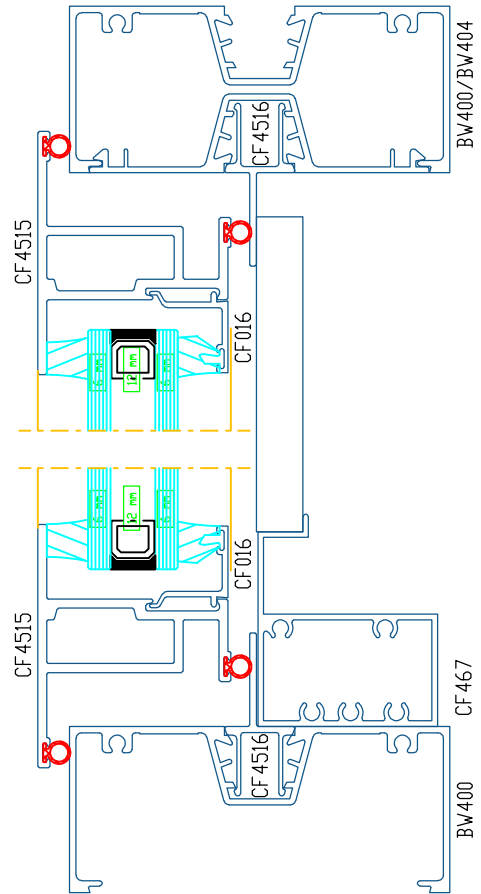
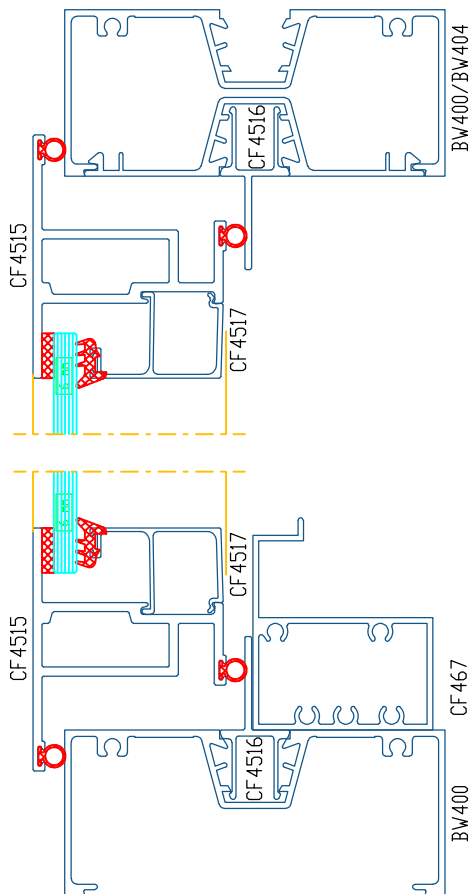
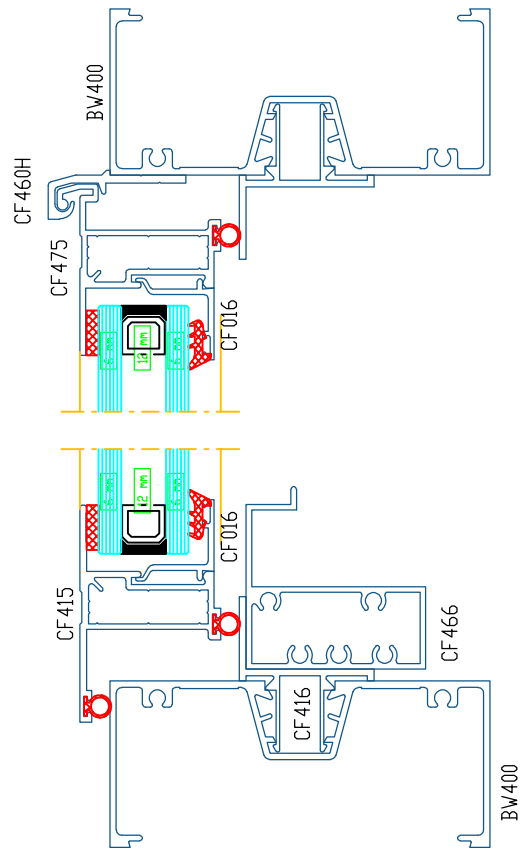
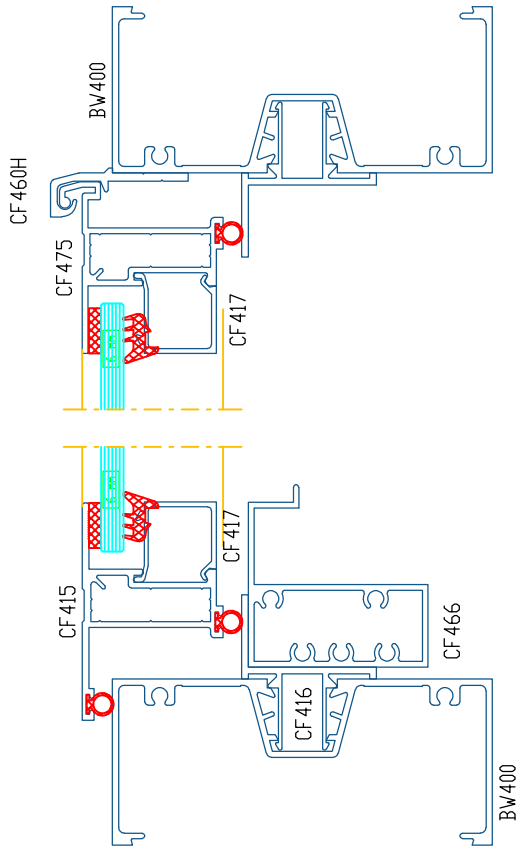

Please note: Images are not to scale

INSERTIONS: COMMERCIAL DOOR SUITES

900 SERIES DOOR: SINGLE GLAZE 73mm X 44mm (accepts CFH6 spigot)
14.5mm glazing pocket = up to 10.38 glass

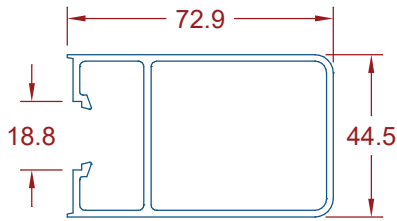

CF907 - SG Plain Stile

Length	Offered Finishes
6.5mtr	Mill / Natural Anodised / Powdercoated

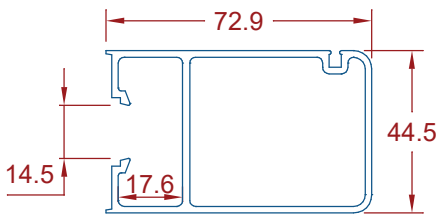

CF908 - SG Sliding Stile

(Accepts: CFH12 Black/Grey Schlegel)

Length	Offered Finishes
6.5mtr	Mill / Natural Anodised / Powdercoated

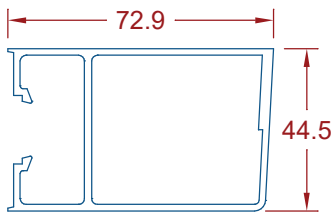

CF909 - SG Hinge Stile

Length	Offered Finishes
6.5mtr	Mill / Natural Anodised / Powdercoated

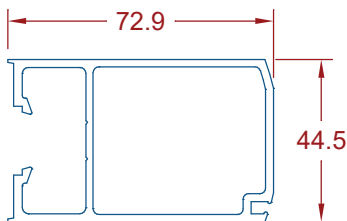

CF910 - SG Lock Stile

(Accepts: CFH12 Black/Grey Schlegel)

Length	Offered Finishes
6.5mtr	Mill / Natural Anodised / Powdercoated

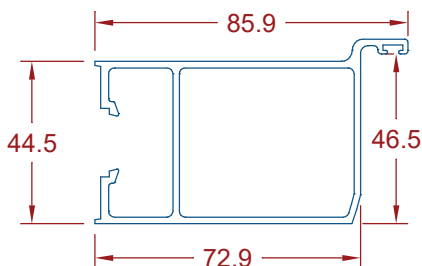

CF911 - SG Meeting Stile (1 piece)

(Accepts: CFH24 Black/Grey Schlegel)

Length	Offered Finishes
6.5mtr	Mill / Natural Anodised / Powdercoated

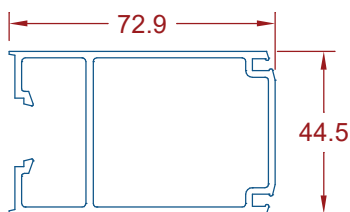

CF912 - Pivot Stile

(Accepts: CFH12 Black/Grey Schlegel)

Length	Offered Finishes
6.5mtr	Mill / Natural Anodised / Powdercoated

Please note: Images are not to scale

INSERTIONS: COMMERCIAL DOOR SUITES

900 SERIES DOOR: SINGLE GLAZE 114mm X 44mm (accepts CFH6 spigot)
14.5mm glazing pocket = up to 10.38 glass

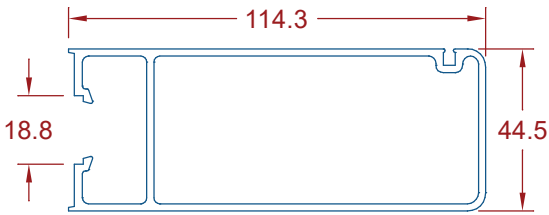

CF001 - SG Wide Sliding Door Stile

(Accepts: **CFH12** Black/Grey Schlegel)

Length	Offered Finishes
6.5mtr	Mill / Natural Anodised / Powdercoated

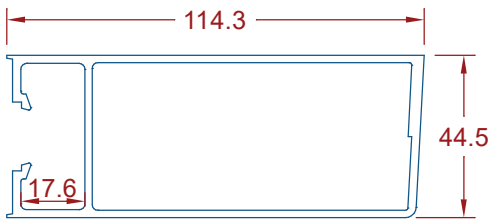

CF002 - SG Wide Hinge Stile

Length	Offered Finishes
6.5mtr	Mill / Natural Anodised / Powdercoated

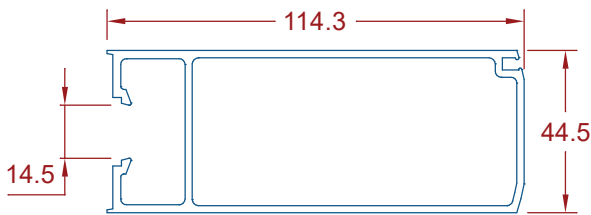

CF003 - SG Wide Lock Stile

(Accepts: **CFH12** Black/Grey Schlegel)

Length	Offered Finishes
6.5mtr	Mill / Natural Anodised / Powdercoated

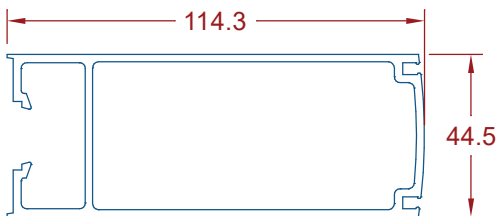

CF004 - SG Wide Pivot Stile

(Accepts: **CFH12** Black/Grey Schlegel)

Length	Offered Finishes
6.5mtr	Mill / Natural Anodised / Powdercoated

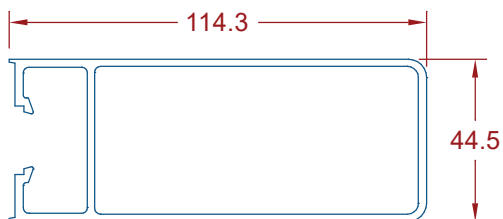

CF005 - SG Wide Plain Stile

Length	Offered Finishes
6.5mtr	Mill / Natural Anodised / Powdercoated

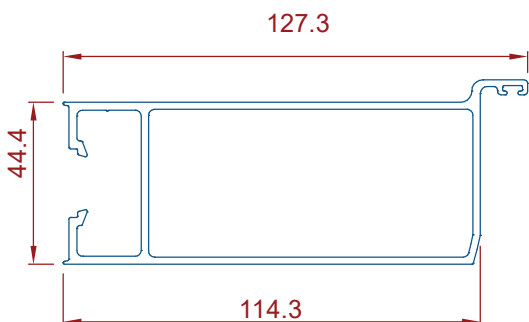

CF006 - SG Wide Meeting Stile (1 piece)

(Accepts: **CFH24** Black/Grey Schlegel)

Length	Offered Finishes
6.5mtr	Mill / Natural Anodised / Powdercoated

Please note: Images are not to scale

INSERTIONS: COMMERCIAL DOOR SUITES

900 SERIES COMMERCIAL DOOR RAILS (SINGLE GLAZED)

ACCEPTS CFH6 SPIGOT

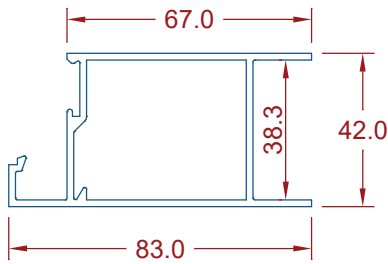

CF411 - SG Top Rail

(Accepts: CF414)

Length	Offered Finishes
6.5mtr	Mill / Natural Anodised / Powdercoated

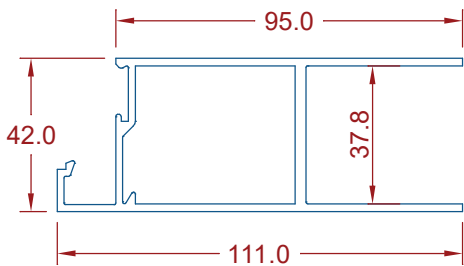

CF412 - SG Bottom Rail

(Accepts: CF414)

Length	Offered Finishes
6.5mtr	Mill / Natural Anodised / Powdercoated

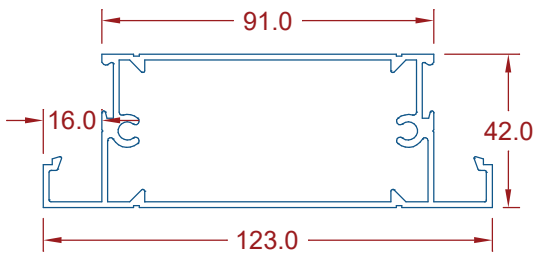

CF413 - SG 123mm Mid Rail

(Accepts: CF414)

Length	Offered Finishes
6.5mtr	Mill / Natural Anodised / Powdercoated

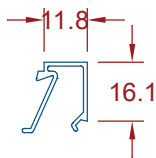

CF414 - SG Door Rail Bead

(Accepts: CF411, CF412, CF413, CF426)

Length	Offered Finishes
6.5mtr	Mill / Natural Anodised / Powdercoated

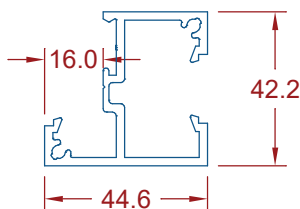

CF426 - SG 45mm Mid Rail

(Accepts: CF414)

Length	Offered Finishes
6.5mtr	Mill / Natural Anodised / Powdercoated

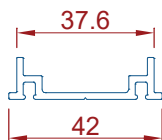

CF448 - Bottom Rail Bug Strip Adaptor

(Accepts: CF411, CF412, CF931, CF932)

(Accepts: **CFH12**)

Length	Offered Finishes
6.5mtr	Mill / Natural Anodised / Powdercoated

*****Please note: Images are not to scale*****

INSERTIONS: COMMERCIAL DOOR SUITES

900 SERIES DOOR: DOUBLE GLAZE 73mm X 44mm (accepts CFH6 spigot)
33mm glazing pocket = up to 28mm IGU (Acoustic)

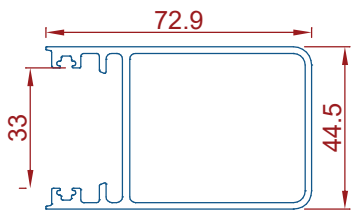

CF917 - DG Plain Stile

(Accepts: **CFH016** Captive Wedge)

Length	Offered Finishes
6.5mtr	Mill / Natural Anodised / Powdercoated

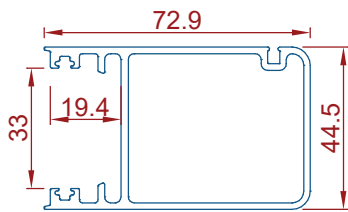

CF918 - DG Sliding Stile

(Accepts: **CFH12** Black/Grey Schlegel & **CFH016** Captive Wedge)

Length	Offered Finishes
6.5mtr	Mill / Natural Anodised / Powdercoated

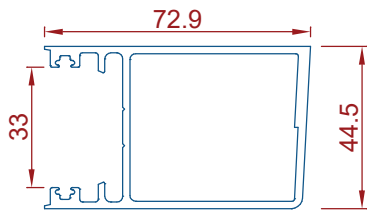

CF919 - DG Hinge Stile

(Accepts: **CFH016** Captive Wedge)

Length	Offered Finishes
6.5mtr	Mill / Natural Anodised / Powdercoated

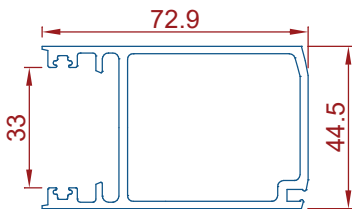

CF920 - DG Lock Stile

(Accepts: **CFH12** Black/Grey Schlegel & **CFH016** Captive Wedge)

Length	Offered Finishes
6.5mtr	Mill / Natural Anodised / Powdercoated

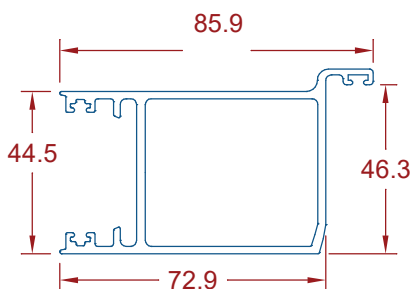

CF921 - DG Meeting Stile

(Accepts: **CFH12** Black/Grey Schlegel & **CFH016** Captive Wedge)

Length	Offered Finishes
6.5mtr	Mill / Natural Anodised / Powdercoated

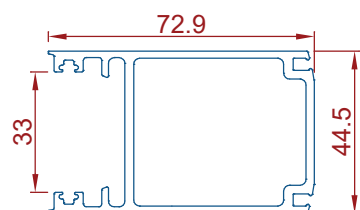

CF922 - DG Pivot Stile

(Accepts: **CFH12** Black/Grey Schlegel & **CFH016** Captive Wedge)

Length	Offered Finishes
6.5mtr	Mill / Natural Anodised / Powdercoated

*****Please note: Images are not to scale*****

INSERTIONS: COMMERCIAL DOOR SUITES

900 SERIES DOOR: DOUBLE GLAZE 114mm X 44mm (accepts CFH6 spigot)
33mm glazing pocket = up to 28mm IGU (Acoustic)

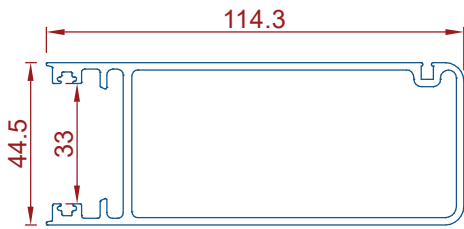

CF021 - DG Wide Sliding Door Stile

(Accepts: **CFH12** Black/Grey Schlegel & **CFH016** Captive Wedge)

Length	Offered Finishes
6.5mtr	Mill / Natural Anodised / Powdercoated

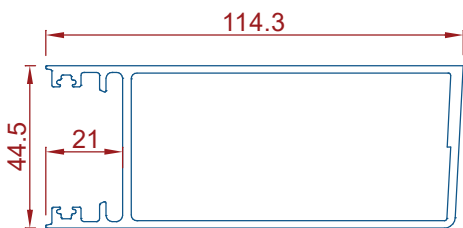

CF022 - DG Wide Hinge Stile

(Accepts: **CFH016** Captive Wedge)

Length	Offered Finishes
6.5mtr	Mill / Natural Anodised / Powdercoated

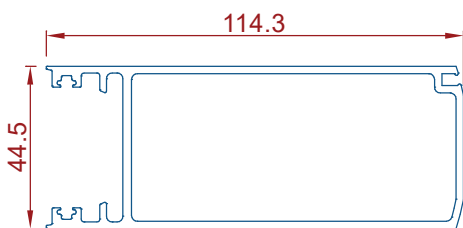

CF023 - DG Wide Lock Stile

(Accepts: **CFH12** Black/Grey Schlegel & **CFH016** Captive Wedge)

Length	Offered Finishes
6.5mtr	Mill / Natural Anodised / Powdercoated

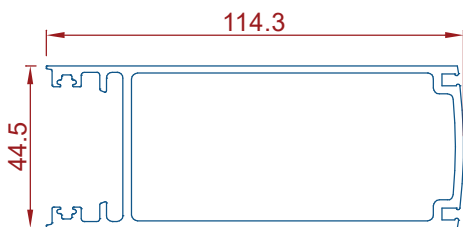

CF024 - DG Wide Pivot Stile

(Accepts: **CFH12** Black/Grey Schlegel & **CFH016** Captive Wedge)

Length	Offered Finishes
6.5mtr	Mill / Natural Anodised / Powdercoated

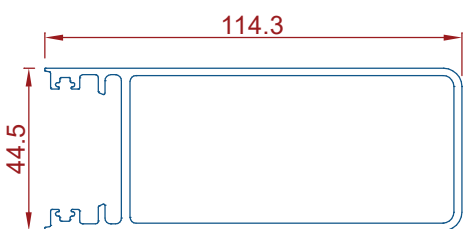

CF025 - DG Wide Plain Stile

(Accepts: **CFH016** Captive Wedge)

Length	Offered Finishes
6.5mtr	Mill / Natural Anodised / Powdercoated

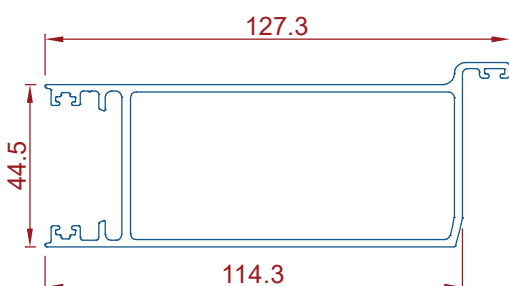

CF026 - DG Wide Meeting Stile (1 piece)

(Accepts: **CFH24** Black/Grey Schlegel)

Length	Offered Finishes
6.5mtr	Mill / Natural Anodised / Powdercoated

Please note: Images are not to scale

INSERTIONS: COMMERCIAL DOOR SUITES

900 SERIES DOOR: DOUBLE GLAZE 114mm X 44mm (accepts CFH6 spigot) 33mm glazing pocket = up to 28mm IGU (Acoustic)

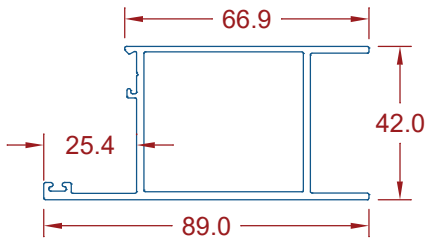

CF931 - DG Top Rail

(Accepts: SF061 & **CFH016** Captive Wedge)

Length	Offered Finishes
6.5mtr	Mill / Natural Anodised / Powdercoated

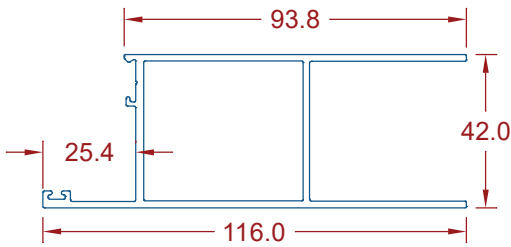

CF932 - DG Bottom Rail

(Accepts: SF061 & **CFH016** Captive Wedge)

Length	Offered Finishes
6.5mtr	Mill / Natural Anodised / Powdercoated

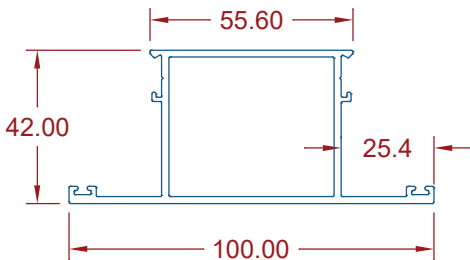

CF933 - DG Mid Rail

(Accepts: SF061 & **CFH016** Captive Wedge)

Length	Offered Finishes
6.5mtr	Mill / Natural Anodised / Powdercoated

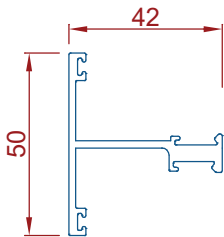

CF934 - DG 50mm Mid Rail

(Accepts: SF061 & **CFH016** Captive Wedge)

Length	Offered Finishes
6.5mtr	Mill / Natural Anodised / Powdercoated

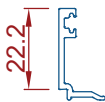

SF061 - DG Door Rail Bead

(Accepts: CF931, CF932, CF933 & **CFH016** Captive Wedge)

Length	Offered Finishes
6.5mtr	Mill / Natural Anodised / Powdercoated

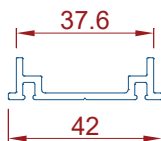

CF448 - Bottom Rail Bug Strip Adaptor

(Accepts: CF411, CF412, CF931, CF932)

(Accepts: **CFH12**)

Length	Offered Finishes
6.5mtr	Mill / Natural Anodised / Powdercoated

Please note: Images are not to scale

INSERTIONS: COMMERCIAL DOOR SUITES

900 SERIES DOOR: SINGLE/DOUBLE GLAZE SPIGOT OPTIONS (1 door = 4 each)

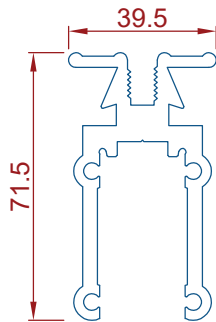

CFH6 - 900 Series Spigot

(Accepts: **ALL** 900 series Door Stiles & Rails)

Unit	Offered Finishes
Each or bags of 100	Mill finish only

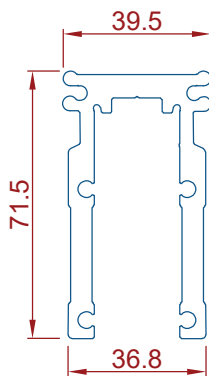
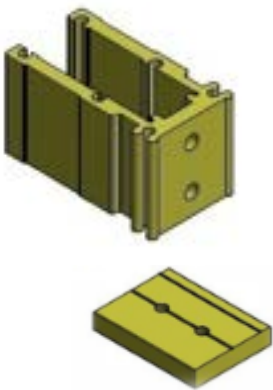

CFH43 - Heavy Duty Spigot with Back Plate

(Accepts: **DG** 900 Series Door Stiles & Rails **ONLY**)

Unit	Offered Finishes
Each or bags of 100	Mill finish only

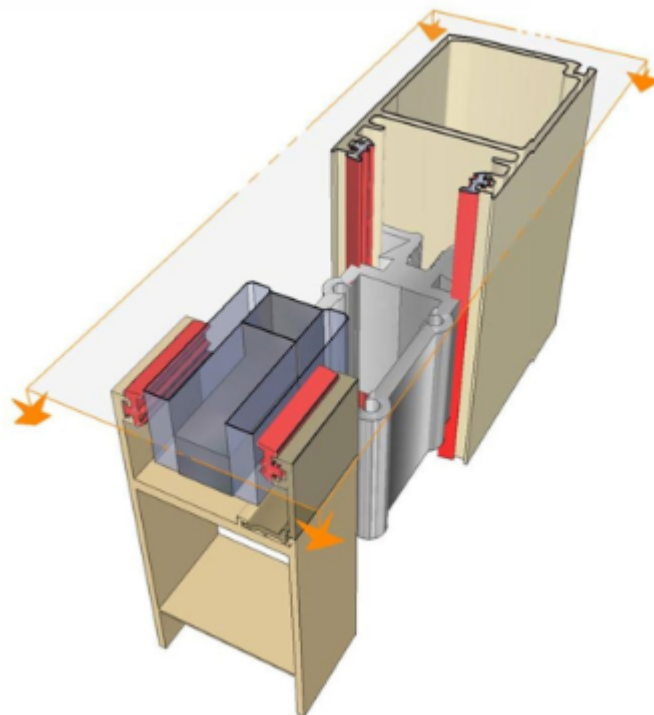

Please note: Images are not to scale

INSERTIONS: COMMERCIAL DOOR SUITS

DOOR MISCELLANEOUS: TRACKS, GUIDES & ATTACHEMENTS

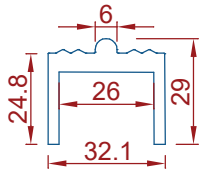

CF421 - Sliding Door Track Insert

Length	Offered Finishes
6.5mtr	Mill / Natural Anodised / Powdercoated

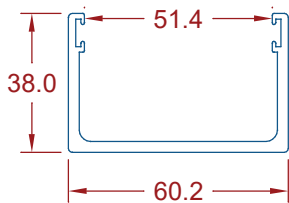

CF422 - Door Floor Guide

(Accepts: **CFH16**)

Length	Offered Finishes
6.5mtr	Mill / Natural Anodised / Powdercoated

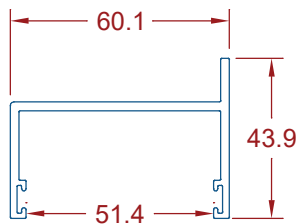

CF424 - Sliding Door Guide

(Accepts: **CFH16**)

Length	Offered Finishes
6.5mtr	Mill / Natural Anodised / Powdercoated

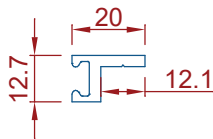

CF429 - Plant On Door Stop

(Accepts: **CFH4** Door Stop Rubber)

Length	Offered Finishes
6.5mtr	Mill / Natural Anodised / Powdercoated



CF441 - Sliding Stile Interlock

(Accepts: **CFH4** Door Stop Rubber)

Length	Offered Finishes
6.5mtr	Mill / Natural Anodised / Powdercoated

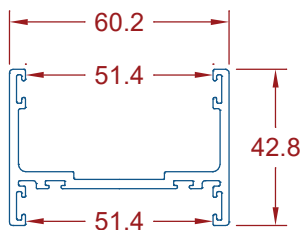

CF446 - Sliding Guide/Receiver

(Accepts: **CFH16**)

Length	Offered Finishes
6.5mtr	Mill / Natural Anodised / Powdercoated

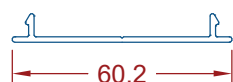

CF447 - Guide/Receiver Cover

Length	Offered Finishes
6.5mtr	Mill / Natural Anodised / Powdercoated

Please note: Images are not to scale

INSERTIONS: COMMERCIAL DOOR SUITS

DOOR MISCELLANEOUS: TRACKS, GUIDES & ATTACHEMENTS

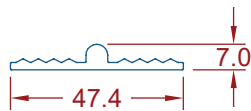

CF445 - Single track

(Accepts: **CFH445** Bottom Roller)

Length	Offered Finishes
6.5mtr	Mill / Natural Anodised / Powdercoated

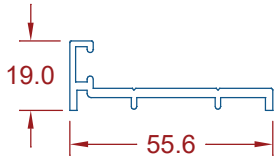

CF449 - Plant On Door Stop

(Accepts: **CFH4** Door Stop Rubber)

Length	Offered Finishes
6.5mtr	Mill / Natural Anodised / Powdercoated

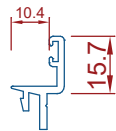

CF455 - Meeting Stile Adaptor

(Accepts: Lock & Pivot Stile Pile Groove & **CFH24**)

Length	Offered Finishes
6.5mtr	Mill / Natural Anodised / Powdercoated

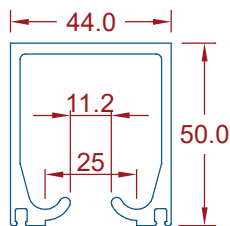

CF461 - Top Track (MAX 150kg load)

(Accepts: **CFH19** Roller)

Length	Offered Finishes
6.5mtr	Mill / Natural Anodised / Powdercoated

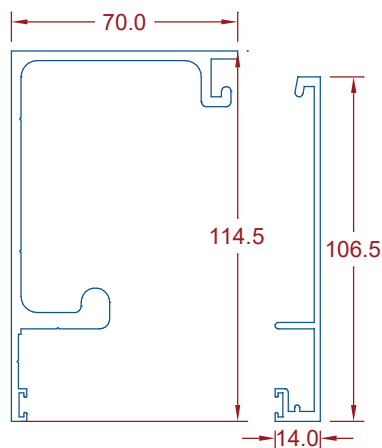

CF453 -114mm Overhead Track

(Accepts: CF454 & **CFH16**)

Length	Offered Finishes
6.5mtr	Mill / Natural Anodised / Powdercoated

CF454 - Overhead Track Pelmet

(Accepts: CF453 & **CFH16**)

Length	Offered Finishes
6.5mtr	Mill / Natural Anodised / Powdercoated

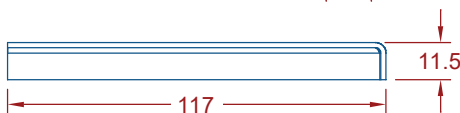

CFH453EC - End Cap

(Accepts: CF454)

Length	Offered Finishes
Pair = 2	Mill / Powdercoated Silver

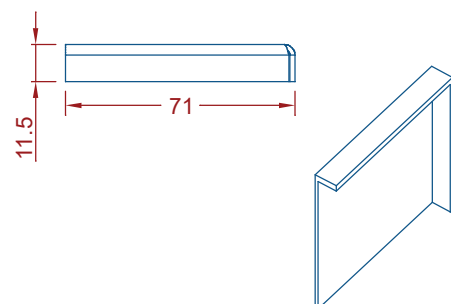

Please note: Images are not to scale

900 SERIES DOOR GLAZING GUIDE

6mm GLASS

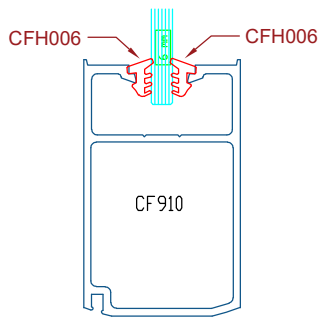

8mm GLASS

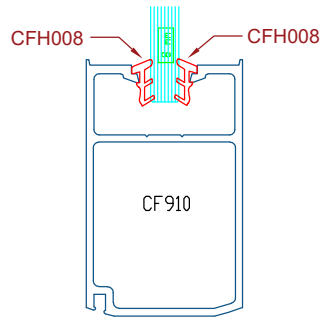

10mm GLASS

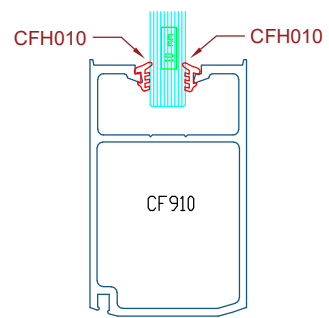

6mm GLASS

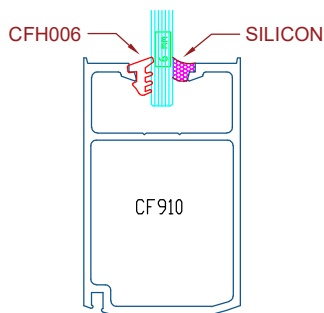

6mm GLASS

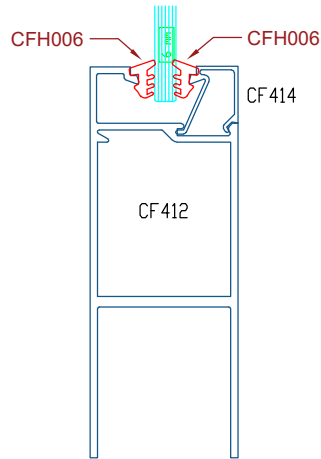

6mm GLASS

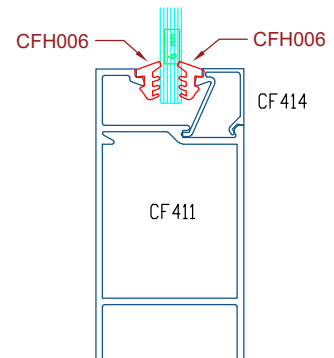

24mm GLASS

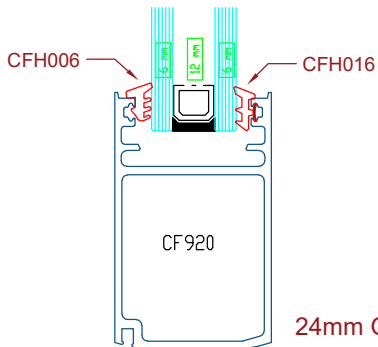

24mm GLASS

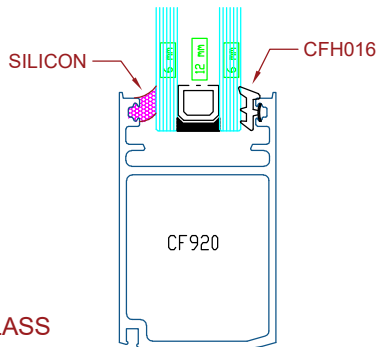

6.5/14/6.38

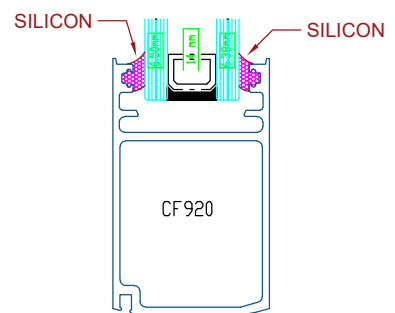

24mm GLASS

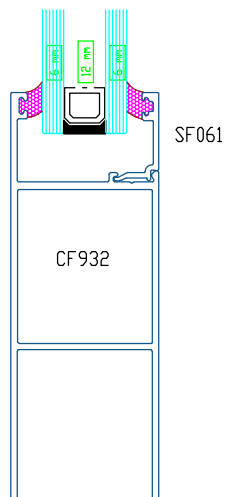

24mm GLASS

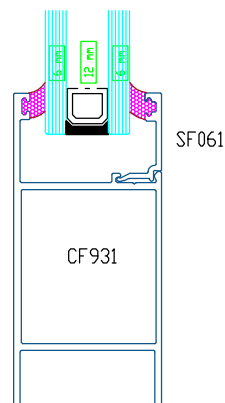

Please note: Images are not to scale

GLAZING CHANNELS

Offered Finishes:
Mill / Natural Anodised or
Powdercoated

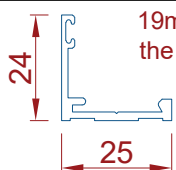
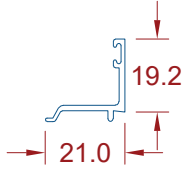
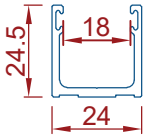
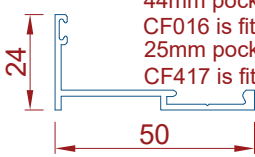
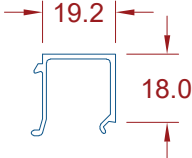
PART No.	LENGTH	DESCRIPTION
CF015	6.5	 <p>19mm pocket after the bead is fitted</p>
CF016	6.5	
CF017	6.5	
CF018	6.5	 <p>44mm pocket after CF016 is fitted 25mm pocket after CF417 is fitted</p>
CF417	6.5	

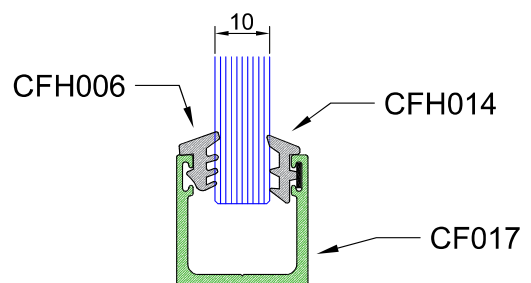
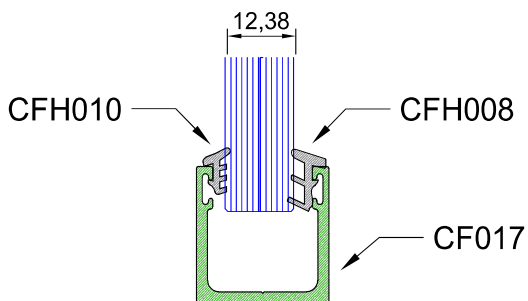

Please note: Images are not to scale

INSERTIONS: COMMERCIAL FIXED LOUVRES

COMMERCIAL FIXED LOUVRES

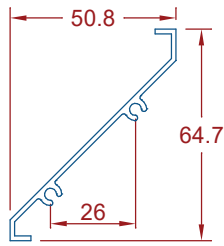

LV001 - 50mm Louvre

(Accepts: LF001) **RECOMMENDED MAX SPAN = 1200mm**

Length	Offered Finishes
6.5mtr	Mill / Natural Anodised / Powdercoated

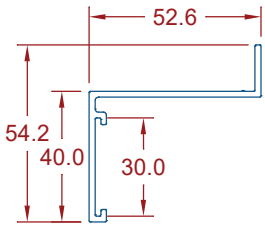

LF001 - 50mm Louvre frame

(Accepts: LV001)

Length	Offered Finishes
6.5mtr	Mill / Natural Anodised / Powdercoated

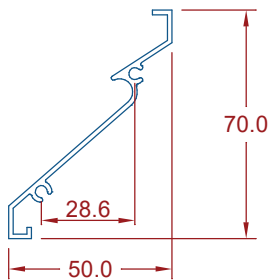

LV050 - 50mm Louvre

(Accepts: LV051) **RECOMMENDED MAX SPAN = 1400mm**

Length	Offered Finishes
6.5mtr	Mill / Natural Anodised / Powdercoated

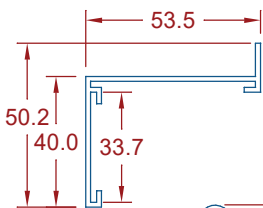

LV051 - 50mm Louvre Frame

(Accepts: LV050)

Length	Offered Finishes
6.5mtr	Mill / Natural Anodised / Powdercoated

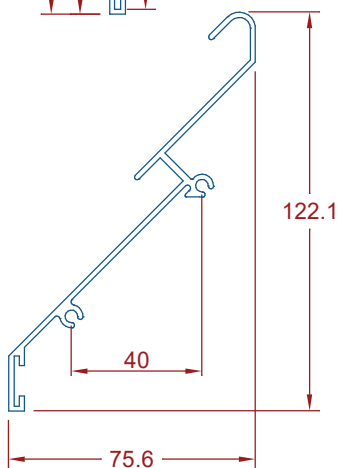

LV7061 - 76mm Clip on Louvre

(Accepts: LV7049) **RECOMMENDED MAX SPAN = 2000mm**

Length	Offered Finishes
6.5mtr	Mill / Natural Anodised / Powdercoated

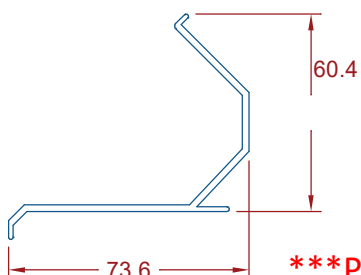

LV7049 - Louvre Clip

(Accepts: LV7061)

Length	Offered Finishes
6.5mtr	Mill / Natural Anodised / Powdercoated

Please note: Images are not to scale

INSERTIONS: COMMERCIAL FIXED LOUVRES

COMMERCIAL FIXED LOUVRES

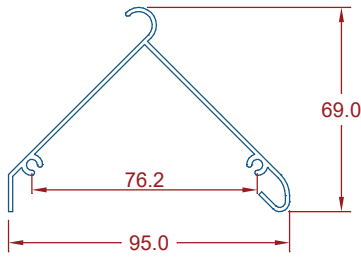

LV9517 - Sub Station Louvre

RECOMMENDED MAX SPAN = 2000mm

Length	Offered Finishes
6.5mtr	Mill / Natural Anodised / Powdercoated

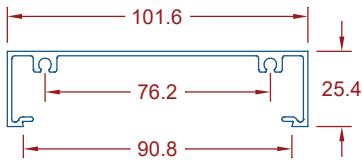

LF436 - Narrow frame

(Accepts: CF405)

Length	Offered Finishes
6.5mtr	Mill / Natural Anodised / Powdercoated

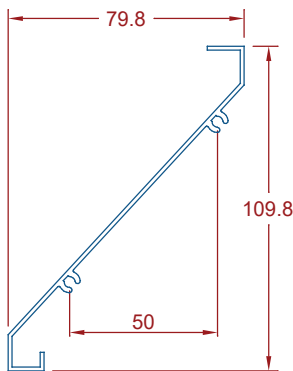

LV100 - 100mm Louvre

(Accepts: LV101)

RECOMMENDED MAX SPAN = 2000mm

Length	Offered Finishes
6.5mtr	Mill / Natural Anodised / Powdercoated

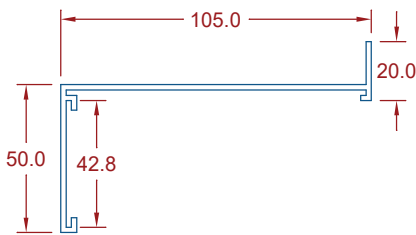

LV101 - 100mm Louvre Frame

(Accepts: LV100)

Length	Offered Finishes
6.5mtr	Mill / Natural Anodised / Powdercoated

A RANGE OF ELIPTICAL LOUVRES ALSO AVAILABLE ON REQUEST

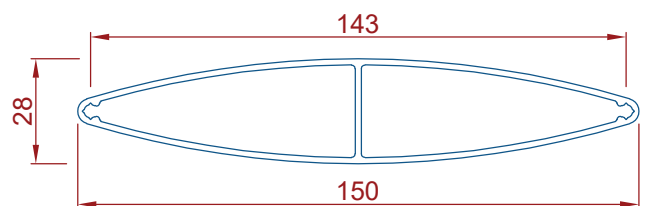
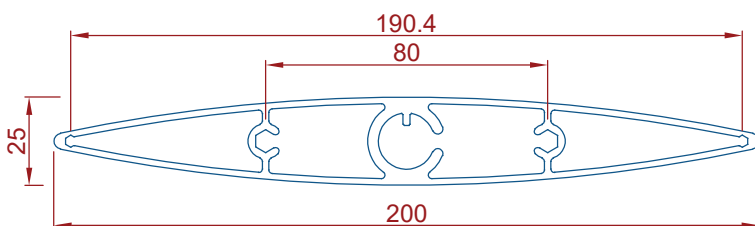
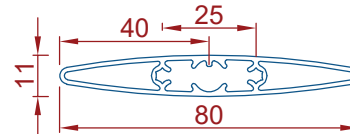
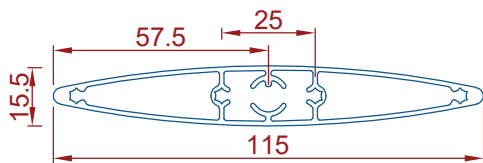
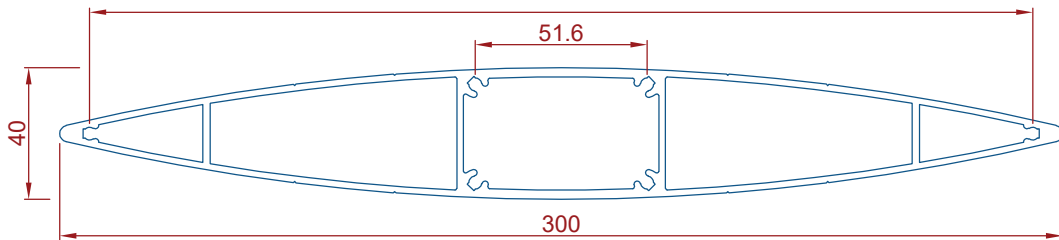

Please note: Images are not to scale

GLAZING WEDGES (SOFT - ROLL-IN)

CFH006 - 6mm Shopfront Wedge

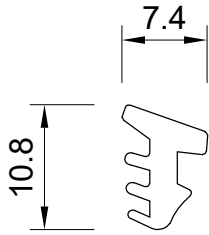

Length	Colour
200mtr	Black

CFH007 - 6mm EG Shopfront Wedge

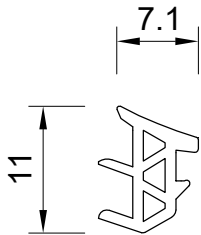

Length	Colour
200mtr	Black

CFH008 - 8mm Shopfront Wedge

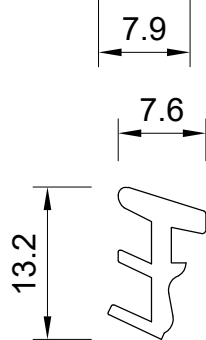

Length	Colour
250mtr	Black

CFH009 - 6mm Front Glaze Roll-in Wedge

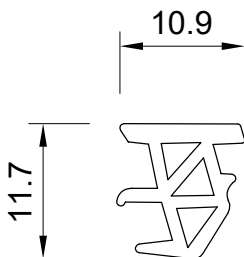

Length	Colour
100mtr	Black

CFH010 - 10mm Shopfront Wedge

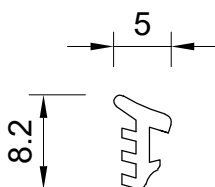

Length	Colour
500mtr	Black

Please note: Images are not to scale

GLAZING WEDGES (CAPTIVE)

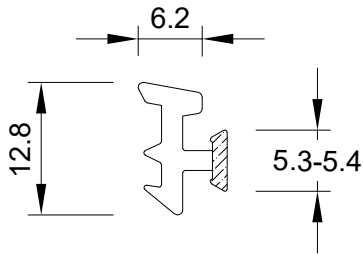

CFH012 - Co-Ex Captive Wedge

(Clear/White Backing)

Length	Colour
150mtr	Black

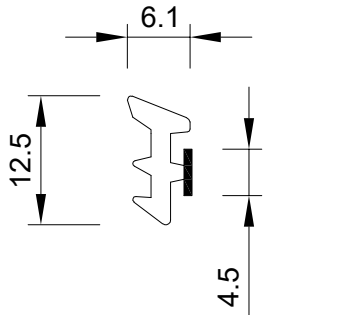

CFH014 - 300 Series Co-Ex Captive Wedge

(Black Backing)

Length	Colour
150mtr	Black

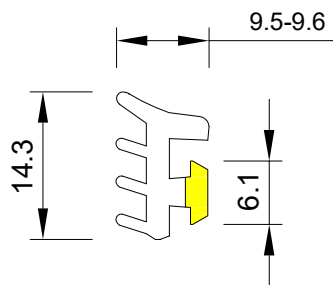

CFH015 - Front Glaze Co-Ex Captive Wedge

(Yellow Backing)

Length	Colour
100mtr	Black

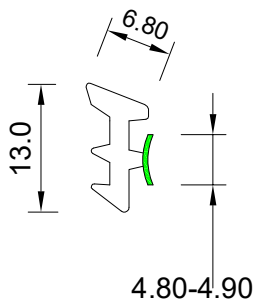

CFH016 - DG Door captive Wedge

(Green Backing)

Length	Colour
150mtr	Black

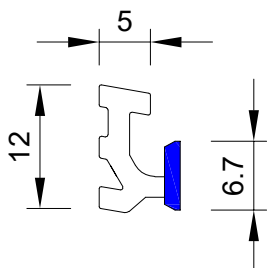

CFH017 -- Front Glaze Co-Ex Captive

(Blue Backing)

Length	Colour
100mtr	Black

Please note: Images are not to scale

SEALS

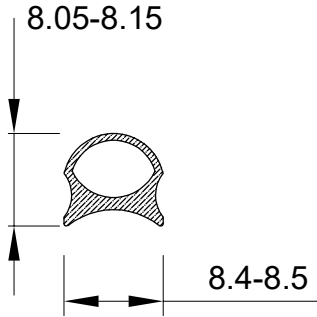

CFH4 - Door Stop Rubber

(Accepts: CF107, CF307, CF332, CF407, CF429, CF432, CF433, CF607, CF707, DG107, DG316, DG317)

Length	Colour
200mtr	Black

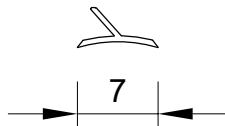

CFH5 - Mullion Seal

(Accepts: CF113, CF128CW, CF174, CF175, CF246, CF252, CF259, CF289, CF427, CF428, CF727, CF728, CF7528, DG128, DG168,

Length	Colour
200mtr	Black

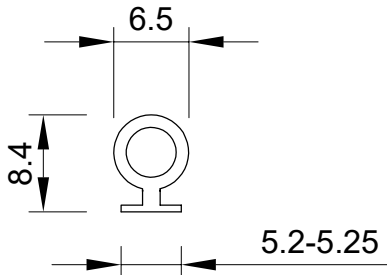

CFH13 - Sash Seal

(Accepts: CF330, CF415, CF430, CF431, CF435, CF437, CF443, CF452, CF457, CF458, CF459, CF462, CF465, CF630, CF7124)

Length	Colour
250mtr	Black

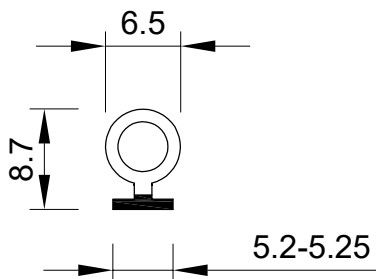

CFH13D - Co-Ex Seal (Hard Backed)

(Accepts: CF330, CF415, CF430, CF431, CF435, CF437, CF443, CF452, CF457, CF458, CF459, CF462, CF465, CF630, CF7124)

Length	Colour
250mtr	Black

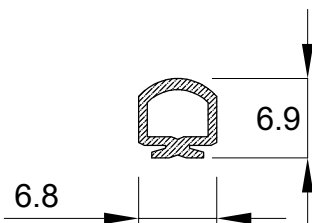

CFH56 - Partitioning Door Stop Seal

(Accepts: All Rapid Partitioning Door Stops)

Length	Colour
150mtr	Black

Please note: Images are not to scale

PILES & FIN SEALS



CFH11 - 9mm Wool Pile Seal (NO FIN)

(Accepts: CF107, CF307, CF332, CF407, CF429, CF432, CF433, CF607, CF707, DG107, DG316, DG317)

Length	Colour
150mtr or per mtr	Black or Grey



CFH12 - 13mm Wool Pile Stile Seal (NO FIN)

(Accepts: CF001, CF003, CF004, CF908, CF910, CF912, CF918, CF920, CF922)

Length	Colour
500mtr or per mtr	Black or Grey



CFH16 - 6.9mm Wool Pile (NO FIN)

(Accepts: Apartment Door, Semi-Commercial Door, Sliding Window & Rapid Partitioning door stops)

Length	Colour
325mtr or per mtr	Black or Grey



CFH24 - 4.8mm Wool Pile Seal (NO FIN)

(Accepts: CF337, CF437, CF455, CF457, CF458, CF911, CF921)

Length	Colour
750mtr or per mtr	Black or Grey



CFH25 - Wool Pile Seal (WITH FIN)

(Accepts: RAD - 401, 402, 404, 601, 602, 604 / RSD - 501, 502, 503, 504, 505 / RSW - 301, 302, 401, 402, 403, 404)

Length	Colour
350mtr or per mtr	Black or Grey

Please note: Images are not to scale

ROLLERS

CFH19 - Top Roller

(Accepts: CF461)



QTY	OPTIONS
Each	Standard (80kg Capacity)

CFH20 - Bottom Roller

(Accepts: C010 - 25 x 25 x 3mm Channel)

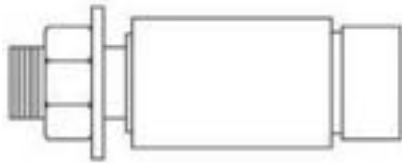

QTY	OPTIONS
Each	Standard

CFH10 - Top Hung Door Roller (250kg)

(Accepts: CF453) To be used with 45mm Top Rail



QTY	OPTIONS
Each	Standard (250kg Capacity)

Please note: Images are not to scale

rapid
ALUMINIUM



RAPID Partition Suite

800 Series & 900 Series

The new benchmark of strength and design reimagined



INTRODUCING OUR NEWEST PARTITION SUITE...

THE 800 SERIES – 100MM (TO SUIT 64MM STUD)

We have redesigned a new suite to cater to the needs of the ever-growing shop fitting and partitions market, with its new and improved robust design our latest addition will surely impress. Our 800 Series is designed 64mm studs application with 13mm plasterboard, While our 900 Series is for 90mm studs. These suites offer a straightforward and effective centre glazing option. Centre glazed is most commonly used glazing option in the market and is by far the easiest to work with for both fabricators and installers alike. These suites have a 14.4mm glazing pocket that can accommodate a wide range of glass options for whatever your project demands. There is also enough clearance within the frame dimensions for the ability to incorporate blinds and other privacy options thanks to the 100.7mm and 131mm framing.

Features of our Partition Suite

- Glazing pocket suitable for 6mm to 10mm glass
- Glazing pocket offers flexibility of either a captive wedge or silicone glazing options
- Plasterboard options:

800 Series

- 13mm plasterboard +64mm studs + 13mm plasterboard
- 2x skin 13mm plasterboard + 51mm studs + 13mm plasterboard

900 Series

- 13mm plasterboard +90mm studs + 13mm

plasterboard

- Offers Door Stop options to suit 35mm, 38mm and 45mm doors
- Gusset Joining System for both window/door frames and ceiling channel provides cleaner looking joins and seamless mitre intersections.

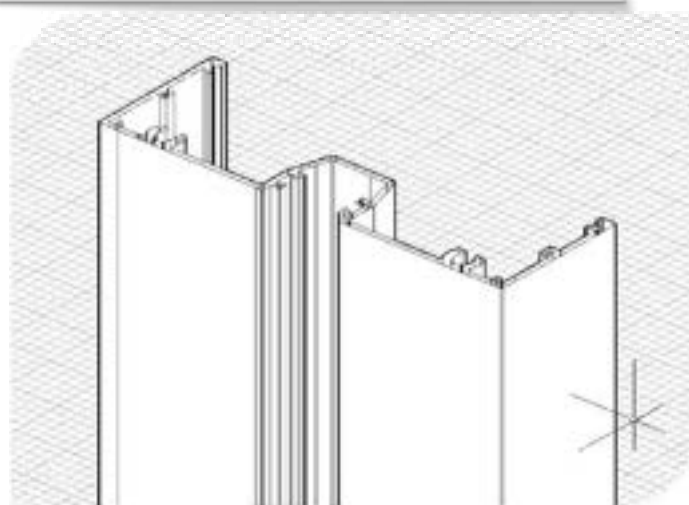

800 SERIES - 100mm (TO SUIT 64mm STUD & 13mm PLASTER)

FRAMES & SILLS

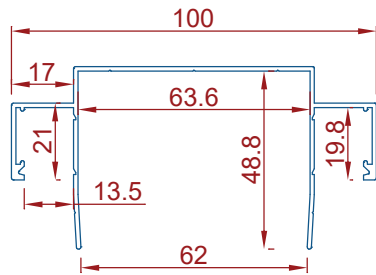

CFP810 - Ceiling Channel (10mm Shadow Line)

(Accepts: 64mm Stud & 13mm Plaster)

Length	Colour
6.5mtr	Mill / Natural Anodised / Powdercoated

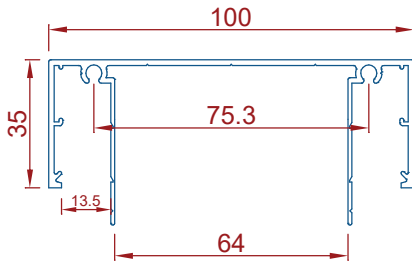

CFP812 - Flat Ceiling Channel

(Accepts: 64mm Stud & 13mm Plaster)

Length	Colour
6.5mtr	Mill / Natural Anodised / Powdercoated

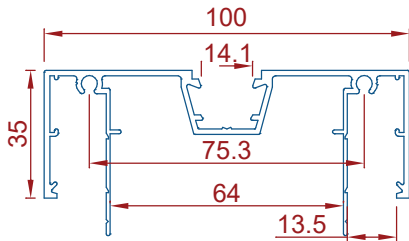

CFP811 - Door Frame (With Legs)

(Accepts: CFP809, CFP807, 64mm Stud & 13mm Plaster)

Length	Colour
6.5mtr	Mill / Natural Anodised / Powdercoated

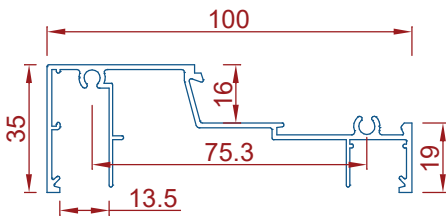

CFP803 - Window Sill

(Accepts: CFP804 Bead)

Length	Colour
6.5mtr	Mill / Natural Anodised / Powdercoated

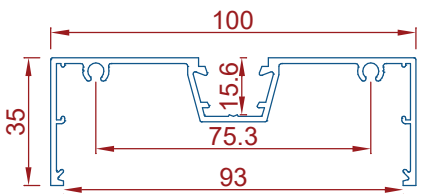

CFP801 - Window Frame

(Accepts: CFP809, CFP807)

Length	Colour
6.5mtr	Mill / Natural Anodised / Powdercoated

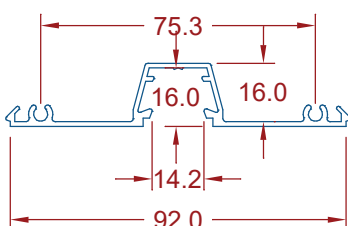

CFP805 - Glazing Adaptor

(Accepts: CFP809, CFP807)

Length	Colour
6.5mtr	Mill / Natural Anodised / Powdercoated

Please note: Images are not to scale

800 SERIES - 100mm (TO SUIT 64mm STUD & 13mm PLASTER)

ADAPTOR, BEAD & DOOR STOPS

CFP804 - Sill Bead

(Accepts: CFP803)

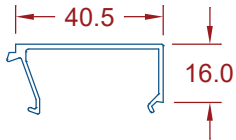

Length	Colour
6.5mtr	Mill / Natural Anodised / Powdercoated

CFP806R - Pocket Filler

(Accepts: CFP801, CFP805, CFP811)



Length	Colour
6.5mtr	Mill / Natural Anodised / Powdercoated

CFP807 - 45mm Door Stop

(Accepts: CFP801, CFP805, CFP811)

(Accepts: CFH16 & CFH56)

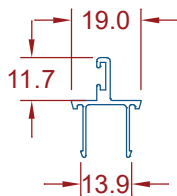

Length	Colour
6.5mtr	Mill / Natural Anodised / Powdercoated

CFP809 - 35mm Door Stop

(Accepts: CFP801, CFP805, CFP811)

(Accepts: CFH16 & CFH56)

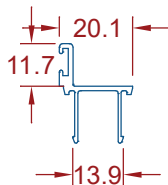

Length	Colour
6.5mtr	Mill / Natural Anodised / Powdercoated

CFP813 - Floor Guide (Mill Finish Only)

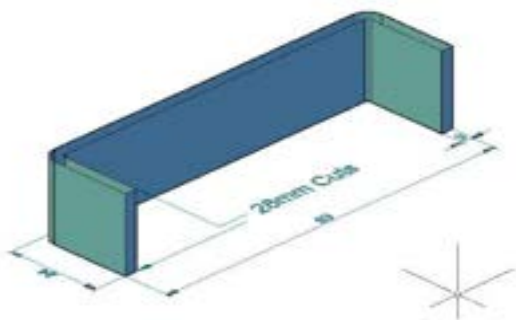

QTY	Colour
EACH	Mill

Please note: Images are not to scale

900 SERIES - 131mm (TO SUIT 90mm STUD & 13mm PLASTER)

FRAMES, SILLS & ADAPTOR

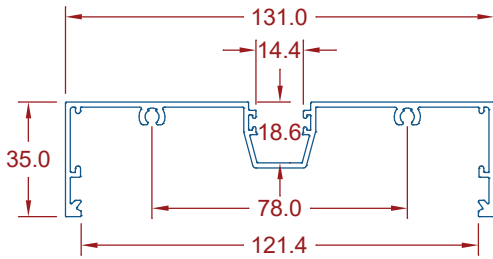

CFP900 - Window Frame

(Accepts: CF306, CFP907, CFP909)

(Accepts: **CFH014**)

Length	Colour
6.0mtr	Mill / Natural Anodised / Powdercoated

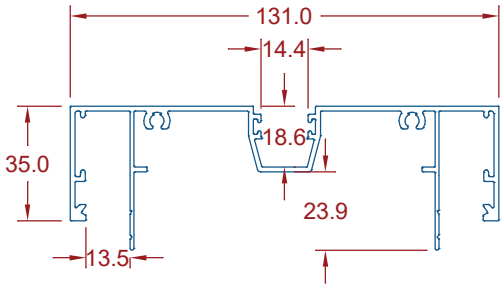

CFP901 - Door Frame (With Legs)

(Accepts: CF306, CFP907, CFP909, 90mm Stud & 13mm Plaster)

(Accepts: **CFH014**)

Length	Colour
6.0mtr	Mill / Natural Anodised / Powdercoated

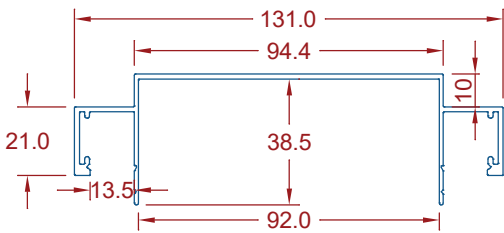

CFP902 - Ceiling Channel (10mm Shadow Line)

(Accepts: 90mm Stud & 13mm Plaster)

Length	Colour
6.0mtr	Mill / Natural Anodised / Powdercoated

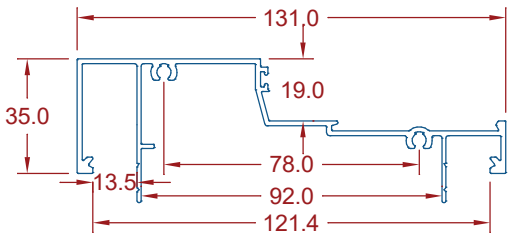

CFP903 - Window Sill

(Accepts: CFP904 Bead)

(Accepts: **CFH014**)

Length	Colour
6.0mtr	Mill / Natural Anodised / Powdercoated

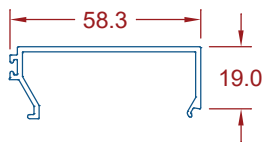

CFP904 - Sill Bead

(Accepts: CFP903)

Length	Colour
6.0mtr	Mill / Natural Anodised / Powdercoated

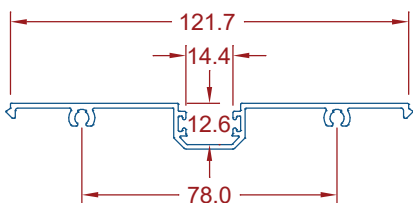

CFP905 - Glazing Adaptor

(Accepts: CF306, CFP900, CFP907, CFP909)

(Accepts: **CFH014**)

Length	Colour
6.0mtr	Mill / Natural Anodised / Powdercoated

Please note: Images are not to scale

900 SERIES - 131mm (TO SUIT 90mm STUD & 13mm PLASTER)

DOOR STOPS & POCKET FILLER

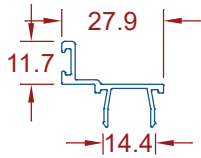

CFP907 - 45mm Door Stop

(Accepts: CFP900, CFP901, CFP905)

(Accepts: **CFH16** & **CFH56**)

Length	Colour
6.5mtr	Mill / Natural Anodised / Powdercoated

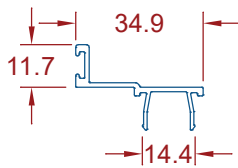

CFP909 - 38mm Door Stop

(Accepts: CFP900, CFP901, CFP905)

(Accepts: **CFH16** & **CFH56**)

Length	Colour
6.5mtr	Mill / Natural Anodised / Powdercoated



CF306 - Pocket Filler

(Accepts: CFP900, CFP901, CFP905)

Length	Colour
6.5mtr	Mill / Natural Anodised / Powdercoated

Please note: Images are not to scale

rapid
ALUMINIUM



600 SERIES – RAPID PARTITION SUITE LITE

Trusted by many of our customers as our longest running partition suite.

600 SERIES - 90mm (TO SUIT 64mm STUD & 13mm PLASTER)

FRAMES, SILLS & ADAPTOR

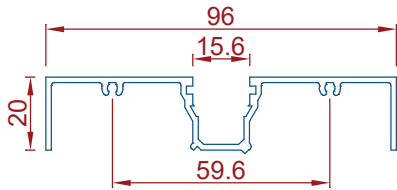

CFP601 - Window Frame

(Accepts: CFP506, CFP607, CFP609)

Length	Colour
6.0mtr	Mill / Natural Anodised / Powdercoated
2.75mtr	

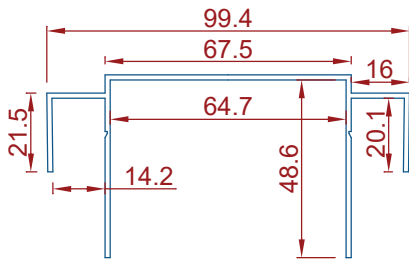

CFP602 - Ceiling Channel (10mm Shadow Line)

(Accepts: 64mm Stud & 13mm Plaster)

Length	Colour
6.0mtr	Mill / Natural Anodised / Powdercoated
2.75mtr	

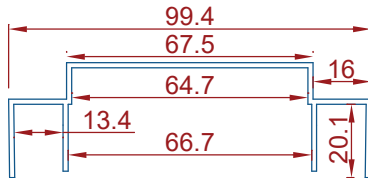

CFP610 - Ceiling Channel (10mm Shadow Line)

(Accepts: 90mm Stud & 13mm Plaster)

Length	Colour
6.0mtr	Mill / Natural Anodised / Powdercoated
2.75mtr	

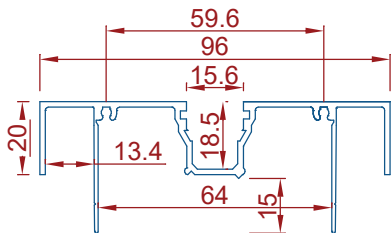

CFP611 - Door Frame (With Legs)

(Accepts: CFP506, CFP607, CFP609)

Length	Colour
6.0mtr	Mill / Natural Anodised / Powdercoated
2.75mtr	

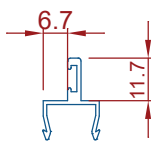

CFP607 - 45mm Door Stop

(Accepts: CFP601, CFP611)

(Accepts: CFH16 & CFH56)

Length	Colour
6.5mtr	Mill / Natural Anodised / Powdercoated

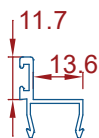

CFP609 - 35mm Door Stop

(Accepts: CFP601, CFP611)

(Accepts: CFH16 & CFH56)

Length	Colour
6.5mtr	Mill / Natural Anodised / Powdercoated

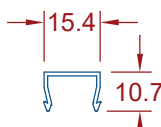

CFP506 - Pocket Filler

(Accepts: CFP601, CFP611)

Length	Colour
6.5mtr	Mill / Natural Anodised / Powdercoated

Please note: Images are not to scale

SKIRTING & PLANKS

SKIRTING

FB018 - 80 x 1.6mm Flat Bar

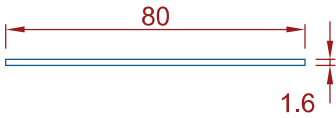

Length	Colour
3.6mtr	Mill / Natural Anodised / Powdercoated

FB020 - 100 x 1.6mm Flat Bar



Length	Colour
3.6mtr	Mill / Natural Anodised / Powdercoated

FB024 - 150 x 1.8mm Flat Bar



Length	Colour
3.6mtr	Mill / Natural Anodised / Powdercoated

SCAFFOLD PLANKS - 240kg MAX SPAN @ 2.6mtr SUPPORTS

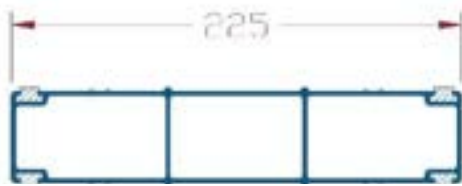

Plank 3 - 3mtr Plank

Length	Colour
3mtr	Mill



Plank 4 - 4mtr Plank

Length	Colour
4mtr	Mill



Plank 5 - 5mtr Plank

Length	Colour
5mtr	Mill



Plank 6 - 6mtr Plank

Length	Colour
6mtr	Mill

ALL PLANKS COMPLETE WITH END CAPS

Please note: Images are not to scale

ANGLES



Offered Finishes:
Mill / Natural Anodised or
Powdercoated

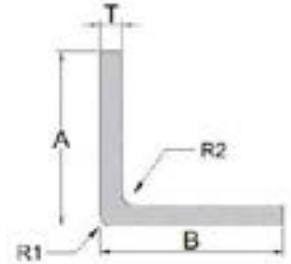

A	B	T	PART No	Length	R1	R2
12	x 12	x 1.6	A001	6.5		
12	x 12	x 3.0	A071	6.5		
15	x 15	x 1.6	A064	6.5		
16	x 16	x 1.6	A002	6.5		
20	x 12	x 1.6	A003	6.5		
20	x 20	x 1.6	A005	6.5		
20	x 20	x 3.0	A006	6.5		
25	x 12	x 1.6	A007	6.5		
25	x 20	x 1.6	A009	6.5		
25	x 20	x 3.0	A035	6.5		
25	x 25	x 1.6	A010	6.5		
25	x 25	x 3.0	A011	6.5		
32	x 20	x 1.6	A012	6.5		
32	x 25	x 3.0	A013	6.5		
32	x 32	x 1.6	A033	6.5		
32	x 32	x 3.0	A015	6.5		
40	x 12	x 1.6	A016	6.5		
40	x 20	x 1.6	A017	6.5		
40	x 20	x 3.0	A040	6.5		
40	x 25	x 1.6	A019	6.5		
40	x 25	x 3.0	A018	6.5		
40	x 40	x 1.6	A020	6.5		
40	x 40	x 3.0	A021	6.5		
40	x 40	x 6.0	A022	6.5		
50	x 25	x 1.6	A023	6.5		
50	x 25	x 3.0	A024	6.5		
50	x 50	x 1.6	A025	6.5		
50	x 50	x 3.0	A026	6.5		
50	x 50	x 6.0	A027	6.5		
70	x 25	x 1.6	A028	6.5		
70	x 40	x 1.6	A029	6.5		
76.2	x 50.8	x 6.35	A034	5.5		
76	x 76	x 3.0	A054	6.5		
80	x 80	x 6.0	A031	6.5		
90	x 40	x 1.6	A069	6.5		
100	x 50	x 3.0	A043	6.5		
100	x 50	x 6.0	A037	6.5		4
100	x 100	x 6.0	A032	6.5		
125	x 50	x 3.0	A030	6.5		

Anodised ONLY

Please note: Images are not to scale

RECTANGLE HOLLOW (RHS)

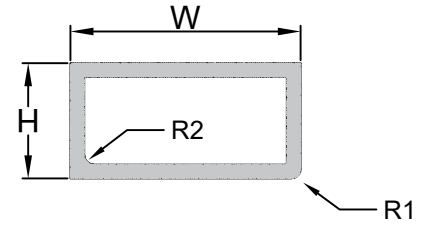

Offered Finishes:
Mill / Natural Anodised or
Powdercoated

STOCKED SIZES

H	W	T	PART No	Length	R1	R2
40	x 25	x 2.5	B005	6.5		
50	x 25	x 3.0	B032	6.5		
60	x 40	x 3.0	B027	6.5		
65	x 16	x 1.4	B073	6.5	3	2
76.2	x 25.4	x 2.4	B037	6.5		
80	x 40	x 3.0	B034	6.5		
100	x 25	x 2.5	B033	6.5		
100	x 50	x 1.6	B020	6.5		
100	x 50	x 3.0	B010	6.5		
150	x 50	x 3.0	B011	6.5		
150	x 50	x 3.0	B124	6.5	2	5
200	x 50	x 3.0	B012	6.5		
250	x 50	x 3.0	B093	6.5		

Anodised Available

OTHER MILL RUN SIZES AVAILABLE ON REQUEST

4-6 week lead time

H	W	T	PART No	Length	R1	R2
50	x 19	x 1.2	E4007	MILL RUN		
50	x 38	x 3.0	E0224	MILL RUN		
60	x 20	x 1.6	E0251	MILL RUN		
60	x 50	x 3.0	E0449	MILL RUN		
75	x 15	x 2.0	E2281	MILL RUN		
76.2	x 38.1	x 3.2	E0186	MILL RUN		
80	x 50	x 3.0	E0183	MILL RUN		
100	x 40	x 2.0	E0229	MILL RUN		
100	x 50	x 3.0	E3357	MILL RUN	3	
125	x 50	x 3.0	E0208	MILL RUN		
150	x 25	x 2.0	E2755	MILL RUN		
152	x 76	x 6.0	C13822	MILL RUN	2	6
160	x 100	x 3.0	C22154	MILL RUN		
200	x 12	x 3.0	E4372	MILL RUN		
300	x 50	x 3.0	C15970	MILL RUN	0.5	0.5
365	x 100	x 6.0	C8251	MILL RUN		

With centre web

Please note: Images are not to scale

SQUARE HOLLOW (SHS)

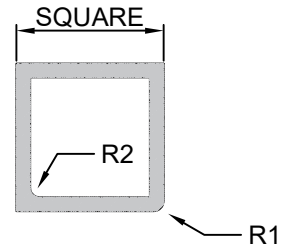

Offered Finishes:
Mill / Natural Anodised or
Powdercoated

STOCKED SIZES

A	B	T	PART No	Length	R1	R2
25	x 25	x 3.0	B003	6.5		
25.4	x 25.4	x 1.2	B064	6.5		
32	x 32	x 1.6	B013	6.5		
32	x 32	x 3.0	B014	6.5		
40	x 40	x 1.6	B017	6.5		
40	x 40	x 3.0	B018	6.5		
50	x 50	x 1.6	B019	6.5		
50	x 50	x 3.0	B024	6.5		
65	x 65	x 2.5	B022	6.5		
100	x 100	x 3.0	B021	6.5		

5.4mtr also stocked

OTHER MILL RUN SIZES AVAILABLE ON REQUEST

4-6 week lead time

A	B	T	PART No	Length	R1	R2
12	x 12	x 1.6	E8001	MILL RUN		
16	x 16	x 1.2	E4681	MILL RUN	1.6	0.4
19	x 19	x 1.2	E12679	MILL RUN	1	
38	x 38	x 2.0	E9743	MILL RUN		
45	x 45	x 2.5	E22109	MILL RUN		
50	x 50	x 4.0	E15366	MILL RUN		
60	x 60	x 3.0	E12806	MILL RUN		
62	x 62	x 5.0	E13805	MILL RUN	2	6
75	x 75	x 4.0	E9568	MILL RUN		
80	x 80	x 2.5	E13188	MILL RUN	3	1
90	x 90	x 2.0	E22379	MILL RUN	3	1
100	x 100	x 6.0	E8009	MILL RUN		
127	x 127	x 6.35	E5620	MILL RUN	12.70	6.35
150	x 150	x 3.0	E13699	MILL RUN	3	1.6
178	x 178	x 9.0	E4953	MILL RUN	8	5

Please note: Images are not to scale

CHANNEL



Offered Finishes:
Mill / Natural Anodised or
Powdercoated

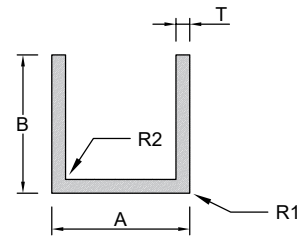

STOCKED SIZES

A	B	T	PART No	Length	R1	R2
12	x 12	x 1.6	C002	6.5		
16	x 16	x 1.6	C004	6.5		
20	x 20	x 1.6	C006	6.5		
20	x 20	x 3.0	C007	6.5		
25	x 25	x 3.0	C010	6.5		
25	x 40	x 3.0	C011	6.5		
32	x 25	x 3.0	C013	6.5		
40	x 25	x 3.0	C015	6.5		
40	x 40	x 3.0	C023	6.5		
50	x 25	x 3.0	C016	6.5		
50	x 50	x 3.0	C017	6.5		

OTHER MILL RUN SIZES AVAILABLE ON REQUEST

4-6 week lead time

A	B	T	PART No	Length	R1	R2
40	x 60	x 3.0	E0279	MILL RUN		
42.5	x 50	x 3.0	E1974	MILL RUN		
60	x 32	x 3.0	E0087	MILL RUN		
80	x 25	x 3.0	E0066	MILL RUN		
80	x 40	x 3.0	E0044	MILL RUN		
100	x 25	x 3.0	E0099	MILL RUN		
100	x 40	x 3.0	E0128	MILL RUN		
100	x 50	x 3.0	E0198	MILL RUN		
100	x 50	x 5.0	E3356	MILL RUN	6	
144	x 65	x 6.0	E4362	MILL RUN		

Please note: Images are not to scale

FLAT BAR

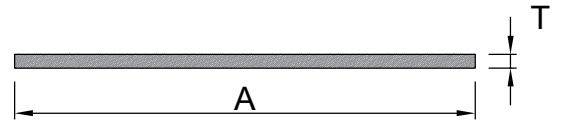

Offered Finishes:
Mill / Natural Anodised or
Powdercoated

STOCKED SIZES

A	T	PART No	Length
10	x 3.0	FB001	4.0
12	x 3.0	FB002	4.0
16	x 3.0	FB003	4.0
20	x 1.6	FB005	4.0
20	x 3.0	FB006	4.0
20	x 6.0	FB059	4.0
25	x 1.6	FB007	4.0
25	x 3.0	FB008	4.0
25	x 6.0	FB013	4.0
25	x 10.0	FB041	4.0
32	x 3.0	FB010	4.0
32	x 6.0	FB015	4.0
32	x 10.0	FB038	4.0
40	x 3.0	FB011	4.0
40	x 6.0	FB016	4.0
40	x 10.0	FB022	4.0
50	x 3.0	FB014	4.0
50	x 6.0	FB028	4.0
50	x 10.0	FB029	4.0
50	x 12.0	FB032	4.0
60	x 3.0	FB017	4.0
80	x 1.6	FB018	3.6
80	x 3.0	FB030	4.0
80	x 6.0	FB031	4.0
80	x 10.0	FB019	4.0
100	x 1.6	FB020	3.6
100	x 3.0	FB021	4.0
100	x 6.0	FB034	4.0
100	x 10.0	FB037	4.0
150	x 1.8	FB024	3.6

FB018 AVAILABLE IN ANODISED, FB020 AVAILABLE IN BLACK MATT, WHITE SATIN & ANODISED, FB024 AVAILABLE IN BLACK MATT & ANODISED.

Please note: Images are not to scale

SHEET

Offered Finishes:
Mill / Natural Anodised or
Powdercoated

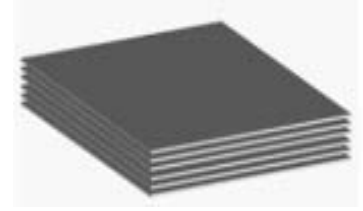

Available in 5005 & 5052

W	L	T	PART No.
900	x 1800	x 1.2	MISC
900	x 1800	x 1.6	MISC
900	x 1800	x 2.0	MISC
900	x 1800	x 2.5	MISC
900	x 1800	x 3.0	SHEET45
900	x 2400	x 3.0	SHEET58
1200	x 2400	x 1.2	SHEET05
1200	x 2400	x 1.6	SHEET01
1200	x 2400	x 2.0	SHEET09
1200	x 2400	x 2.5	SHEET24
1200	x 2400	x 3.0	SHEET11
1200	x 2400	x 4.0	SHEET23
1200	x 2400	x 5.0	SHEET17
1200	x 2400	x 6.0	SHEET32
1200	x 3000	x 1.6	SHEET16
1200	x 3000	x 2.0	SHEET08
1200	x 3000	x 3.0	SHEET03
1200	x 3600	x 1.6	SHEET04
1200	x 3600	x 1.2	SHEET74
1200	x 3600	x 2.0	SHEET06
1200	x 3600	x 3.0	SHEET10
1500	x 2400	x 2.0	SHEET50
1500	x 2400	x 2.5	SHEET39
1500	x 2400	x 3.0	MISC
1500	x 3000	x 1.6	SHEET48
1500	x 3000	x 2.0	SHEET14
1500	x 3000	x 2.5	SHEET72
1500	x 3000	x 3.0	SHEET35
1500	x 3600	x 2.0	SHEET51

#

**TREAD PLATE ALSO AVAILABLE UPON
REQUEST**

Please note: Images are not to scale

MILL RUN LOUVRES & SHROUDS ALSO AVAILABLE

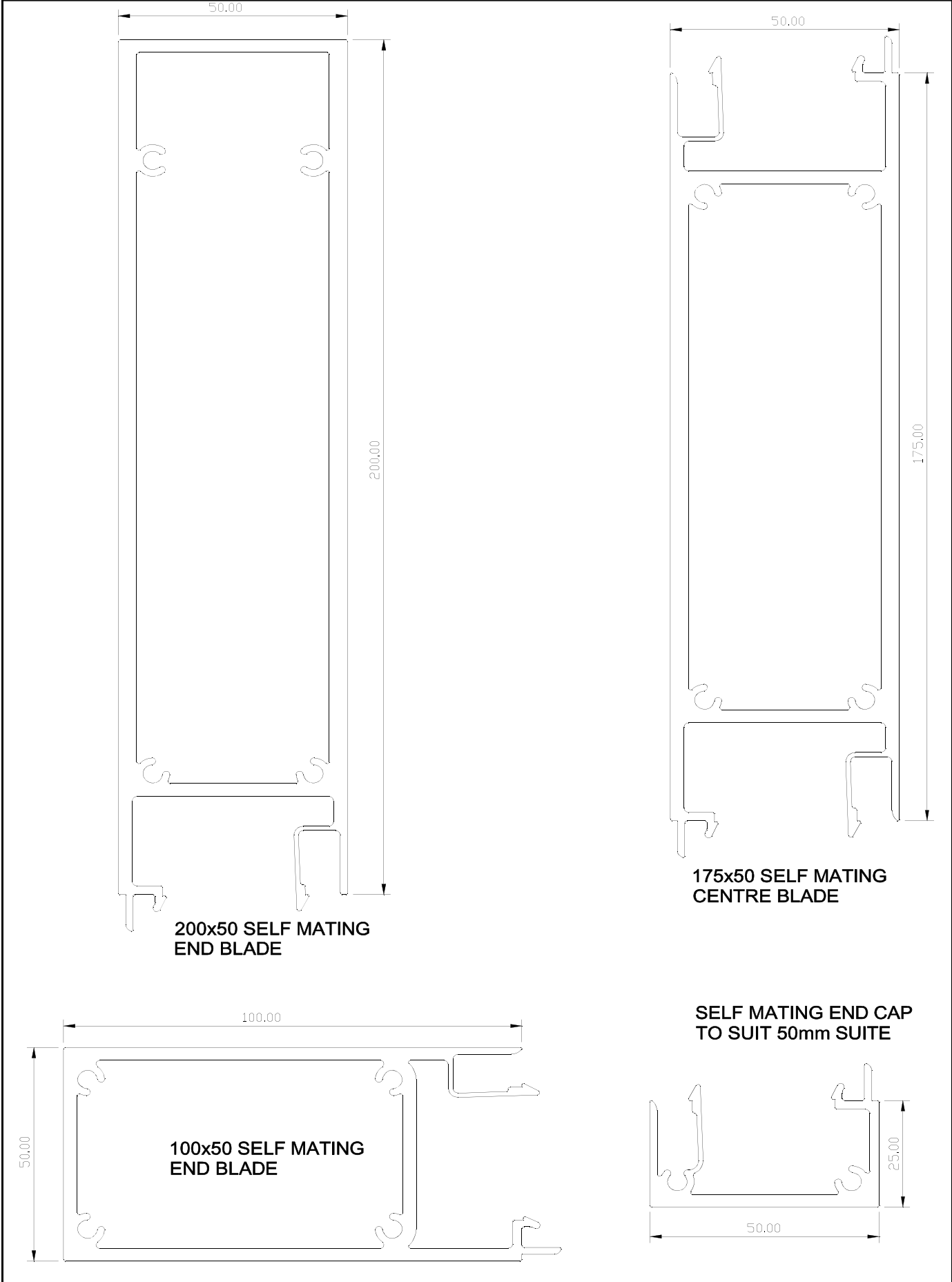

MILL RUN LOUVRES & SHROUDS ALSO AVAILABLE

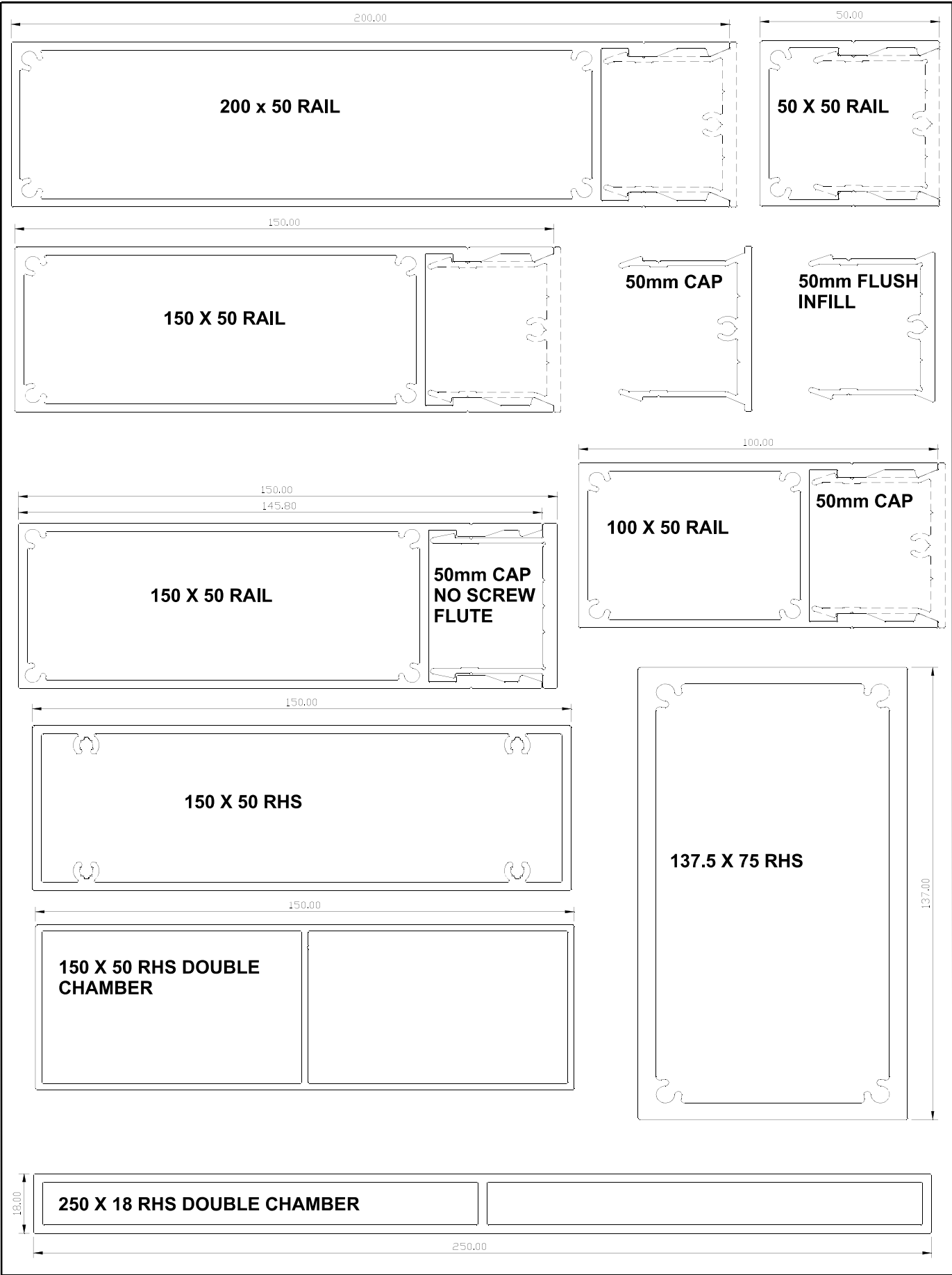

NOTES

QUICK FIND INDEX

PRODUCT	PAGE	PRODUCT	PAGE	PRODUCT	PAGE	PRODUCT	PAGE
ANGLES	130	CF173CW	78	CF420HD	49, 74	CF485	40
BW400	3, 11, 25, 36	CF174CW	78	CF421	110	CF486	41
BW401	37	CF175	78	CF422	110	CF488	41
BW402	36	CF176	78	CF423	38	CF489	51, 76
BW404	37, 54	CF177	78	CF424	110	CF603	54
BW418	42	CF241	86	CF425	38	CF607	55
BW427	38	CF242	86	CF426	105	CF616	55
BW436	37	CF243	93	CF428	38	CF630	17,57,83
BW444	37, 54	CF244	93	CF429	55, 110	CF637	18,57,83
BW601	54	CF246	86	CF429C	55	CF652	91
BW602	54	CF247	86	CF430	17, 49, 74	CF658	18,57,83
BW627	55	CF248	88	CF431R	17, 49, 74	CF669	57,83
CF001	104	CF249	88	CF432	39	CF685	55,79,92
CF002	104	CF250	94	CF433	39	CF701	11,43
CF003	104	CF251	87	CF435	99	CF701L	44
CF004	104	CF252	87	CF437	18, 48, 73	CF702	43
CF005	104	CF252HD	87	CF438	51, 76	CF702L	44
CF006	104	CF253	93	CF439	51, 76	CF703	43
CF015	113	CF254	93	CF441	110	CF703L	44
CF016	98, 100, 113	CF256	93	CF445	111	CF704	43,56
CF017	113	CF257	93	CF446	110	CF704L	44
CF018	113	CF259	87	CF447	110	CF705	16
CF021	107	CF260	94	CF448	105, 108	CF706	43,56
CF022	107	CF261	89	CF449	111	CF707	43
CF023	107	CF277	89	CF450	3, 11, 37	CF7124	39
CF024	107	CF289	87	CF4515	100	CF716	44
CF025	107	CF290	87	CF4516	39	CF717	44
CF026	107	CF291	87	CF4517	100	CF718	45
CF101CW	66	CF292	88	CF451	40	CF727	45
CF102CW	66	CF301	3,59	CF452	16	CF728	45
CF104	66, 77	CF302	59	CF453EC	111	CF751	46
CF105	66	CF303	59	CF454	111	CF752	46
CF106	66, 77	CF304	59	CF455	111	CF7528	46
CF107	69, 79	CF305	59, 62	CF457	18, 48, 57, 73, 83, 89	CF753	46
CF108CW	67	CF306	59, 126	CF458	18, 48, 73	CF754	46
CF109CW	67	CF307	60	CF460H	99	CF756	47
CF110CW	67	CF316	60	CF461	111	CF757	47
CF111	67, 71, 79, 81	CF318	60	CF462	17, 49, 74	CF758	47
CF112	69	CF330	61	CF462N	17, 50, 75, 89	CF772	45
CF113	67	CF332	60	CF463N	50, 75	CF8131	42
CF114CW	67	CF337	61	CF466	40	CF907	103
CF115CW	66	CF351	61	CF467	40	CF908	103
CF116	68, 79	CF403	36	CF468	51, 76	CF909	103
CF117	69	CF403B	36	CF469	51, 76	CF910	103
CF125	68	CF405	36, 46, 54, 69, 86	CF470	38	CF911	103
CF126	68	CF406	16,38,55	CF471	40	CF912	103
CF127CW	68	CF407	39	CF472	37	CF917	106
CF128CW	68	CF411	105	CF473	41	CF918	106
CF156	68, 79	CF412	105	CF475	98	CF919	106
CF161CW	77	CF413	105	CF475B	98	CF920	106
CF162CW	77	CF414	99, 105	CF477	18, 48, 73	CF921	106
CF164CW	77	CF415	98	CF478	51,76	CF922	106
CF165	77	CF415B	98	CF479	89	CF931	108
CF169CW	78	CF416	39	CF480	89	CF932	108
CF170CW	78	CF417	98, 100, 113	CF483	86	CF933	108
CF171CW	79	CF420	17, 49, 74	CF484	40	CF934	108

QUICK FIND INDEX

PRODUCT	PAGE	PRODUCT	PAGE	PRODUCT	PAGE	PRODUCT	PAGE
CFH10	120	CFP813	124	LV050	114	RAD604	10
CFH110	7, 33	CFP900	125	LV051	114	RAD605	10
CFH111	7, 33	CFP901	125	LV100	115	RHS	131
CFH113	7, 32	CFP902	125	LV101	115	RSD501	24
CFH114	32	CFP903	125	LV7049	114	RSD502	24
CFH115	7, 20, 32	CFP904	125	LV7061	114	RSD503	24
CFH116	21	CFP905	125	LV9517	115	RSD504	24
CFH118	21	CFP907	126	MOHAIR	119	RSD505	25
CFH117	21	CFP909	126	PLANKS	129	RSD506	25
CFH119	20	DG107	72, 82	RA131	16	RSD507	25
CFH120	20	CHANNEL	133	RA267	90	RSD508	25
CFH121	20	DG101	70	RA200	3	RSD509	27
CFH122	20	DG105	71	RA261	90	RSD510	29
CFH123	22, 33	DG106	70, 82	RA262	90	RSD511	27
CFH124	19	DG107	72, 82	RA265	77, 80, 90	RSD512	29
CFH18	7, 20, 32	DG108	70	RA266	90	RSD513	27
CFH19	120	DG109	70	RA267	90	RSD514	29
CFH20	120	DG110	71	RA268	91	RSD515	25
CFH29	19	DG112	70	RA271	91	RSD520	30
CFH3	99	DG113	70, 80	RA272	91	RSD521	30
CFH30	3	DG114	70	RA276	91	RSD523	30
CFH37	8, 21, 33	DG116	72, 82	RA278	92	RSD524	24
CFH38D	8, 21, 33	DG117	67, 71, 79, 81	RA279	92	RSD525	24
CFH40	8, 21, 33	DG127	71	RA280	92	RSD526	30
CFH43	109	DG128	71	RA281	92	RSD527	30
CFH453EC	111	DG156	72, 82	RAD105	12	RSD528	3, 27
CFH50	100	DG161	80	RAD106	12	RSW301	2
CFH6	109	DG164	80	RAD107	12	RSW302	2
CFH80	7, 32	DG167	80	RAD108	12	RSW401	2
CFH81	7, 32	DG168	80	RAD109	15	RSW402	2
CFH90	6, 19, 31	DG169	81	RAD110	15	RSW403	2
CFH92	6, 19, 31	DG170	81	RAD111	15	RSW404	2, 25
CFH93	6, 19, 31	DG171	81	RAD112	12	RSW406	4, 26
CFH94	6, 19, 31	DG172	80	RAD113	14	RSW407	5, 28
CFH95	6, 31	DG201	81	RAD114	14	RSW408	4, 26
CFH96	6, 20, 31	DG311	62	RAD115	16	RSW409	5, 28
CFH97	8	DG312	62	RAD116	16	RSW410	4, 26
CFH98	22, 33	DG313	62	RAD117	14	RSW411	5, 28
CFH99	22, 33	DG314	62	RAD118	14	RSW412	4, 26
CFP506	128	DG315	62	RAD120	13	RSW413	5, 28
CFP601	128	DG316	63	RAD121	13	RSW414	4, 26
CFP602	128	DG317	63	RAD122	13	RSW415	5, 28
CFP607	128	DG318	63	RAD123	13	RSW416	4, 27
CFP609	128	DG601	56	RAD124	15	RSW417	5, 29
CFP610	128	DG602	56	RAD125	15	RSW418	4, 26
CFP611	128	DG603	56	RAD126	15	RSW419	5, 28
CFP801	123	DG627	56	RAD127	13	RSW420	3
CFP803	123	FB018	129	RAD128	14	RSW421	3,30
CFP804	124	FB020	129	RAD129	14	RSW422	3
CFP805	123	FB024	129	RAD130	11	RSW423	3
CFP806R	124	FLAT BAR	134	RAD131	11	SEALS	118
CFP807	124	FOAM TABS	21, 32	RAD401	10	SF061	108
CFP809	124	H/WARE	121	RAD402	10	SHEET	135
CFP810	123	LF001	114	RAD404	10	SHROUDS	136, 137
CFP811	123	LF436	115	RAD601	10	SHS	132
CFP812	123	LV001	114	RAD603	11	WEDGES	116, 117

For more information and availability, please contact our office.

RAPID ALUMINIUM
27-29 Nathan Road
Dandenong South VIC 3175

PH: +61 3 9792 0344

FAX: +61 3 9792 4954

www.rapidal.com.au

The logo for Rapid Aluminium features the word "rapid" in a bold, italicized blue font with a red underline. Below it, the word "ALUMINIUM" is written in a bold, blue, all-caps sans-serif font.

rapid
ALUMINIUM